

JVC



DVD VIDEO RECORDER

DR-M100S



INSTRUCTIONS

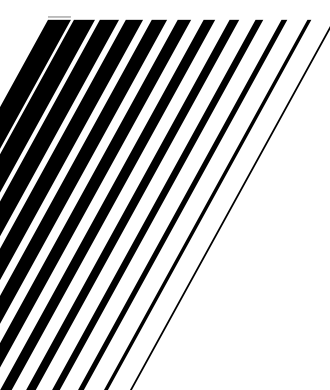

LPT1024-001B

EN

Safety Precautions

The rating plate and the safety caution are on the rear of the unit.

WARNING: DANGEROUS VOLTAGE INSIDE

WARNING: TO PREVENT FIRE OR SHOCK HAZARD, DO NOT EXPOSE THIS UNIT TO RAIN OR MOISTURE.

CAUTION:

A UNIT IS A CLASS 1 LASER PRODUCT. HOWEVER THIS UNIT USES A VISIBLE LASER BEAM WHICH COULD CAUSE HAZARDOUS RADIATION EXPOSURE IF DIRECTED. BE SURE TO OPERATE THE UNIT CORRECTLY AS INSTRUCTED.

WHEN THIS UNIT IS PLUGGED INTO THE WALL OUTLET, DO NOT PLACE YOUR EYES CLOSE TO THE OPENING OF THE DISC TRAY AND OTHER OPENINGS TO LOOK INTO THE INSIDE OF THIS UNIT.

USE OF CONTROLS OR ADJUSTMENTS OR PERFORMANCE OF PROCEDURES OTHER THAN THOSE SPECIFIED HEREIN MAY RESULT IN HAZARDOUS RADIATION EXPOSURE.

DO NOT OPEN COVERS AND DO NOT REPAIR YOURSELF. REFER SERVICING TO QUALIFIED PERSONNEL.

IMPORTANT:

- Please read the various precautions on page 2 – 4 before installing or operating the unit.
- It should be noted that it may be unlawful to re-record pre-recorded tapes, DVDs, or discs without the consent of the owner of copyright in the sound or video recording, broadcast or cable programme and in any literary, dramatic, musical, or artistic work embodied therein.

CAUTION:

- When you are not using the unit for a long period of time, it is recommended that you disconnect the power cord from the mains outlet.
- Dangerous voltage inside. Refer internal servicing to qualified service personnel. To prevent electric shock or fire hazard, remove the power cord from the mains outlet prior to connecting or disconnecting any signal lead or aerial.

CLASS 1 LASER PRODUCT

REPRODUCTION OF LABELS

WARNING LABEL INSIDE OF THE UNIT

CAUTION VISIBLE AND INVISIBLE LASER RADIATION WHEN OPEN. AVOID EXPOSURE TO BEAM. DO NOT STARE INTO BEAM OR VIEW DIRECTLY WITH OPTICAL INSTRUMENTS.

ADVARSEL SYNLIG OG USYNLIG LASERSTRÅLING VED ÅBNING. UNDGÅ UDSAETTELSE FOR STRÅLING SE IKKE IND I STRÅLEN - HELLER IKKE MED OPTISKE INSTRUMENTER.

ADVARSEL SYNLIG OG USYNLIG LASERSTRÅLING NÅR DEKSEL ÅPNES. UNDGÅ EKSPONERING FOR STRÅLEN STIRR IKKE INN I STRÅLEN ELLER SE DIREKTE MED OPTISKE INSTRUMENTER.

VARO! AVATTAESSA OLET ALTTIINA NÄKYVÄÄ JA NÄKYMÄTÖN LASERSÄTEILYLLE. ÄLÄ TUJOTA SÄTEESEEN ÄLÄKÄ KATSO SITÄ OPTISEN LAITTEEN LÄPI.

WARNING SYNLIG OCH OSYNLIG LASERSTRÅLNING NÅR DENNA DEL ÄR ÖPPNAD. STRÅLEN ÄR FARLIG STIRRA EJ IN I STRÅLEN OCH BETRAKTA EJ STRÅLEN MED OPTISKA INSTRUMENT.

OR

CAUTION VISIBLE AND INVISIBLE LASER RADIATION WHEN OPEN. AVOID EXPOSURE TO BEAM. DO NOT STARE INTO BEAM OR VIEW DIRECTLY WITH OPTICAL INSTRUMENTS.	ATTENTION RAYONNEMENTS LASER VISIBLES ET INVISIBLES LORS DE L'OUVERTURE. ÉVITER TOUTE EXPOSITION AU FAISCEAU. NE PAS FIXER DU REGARD LE FAISCEAU OU LE REGARDER DIRECTEMENT VIA DES INSTRUMENTS OPTIQUES.	ADVARSEL SYNLIG OG USYNLIG LASERSTRÅLING VED ÅBNING. UNDGÅ UDSAETTELSE FOR STRÅLING. SE IKKE IND I STRÅLEN. HELLER IKKE MED OPTISKE INSTRUMENTER.	ADVARSEL SYNLIG OG USYNLIG LASERSTRÅLING NÅR DEKSEL ÅPNES. UNDGÅ EKSPONERING FOR STRÅLEN. STIRR IKKE INN I STRÅLEN ELLER SE DIREKTE MED OPTISKE INSTRUMENTER.	VARO! AVATTAESSA OLET ALTTIINA NÄKYVÄÄ JA NÄKYMÄTÖN LASERSÄTEILYLLE. ÄLÄ TUJOTA SÄTEESEEN ÄLÄKÄ KATSO SITÄ OPTISEN LAITTEEN LÄPI.	VARNING SYNLIG OCH OSYNLIG LASERSTRÅLNING NÅR DENNA DEL ÄR ÖPPNAD. STRÅLEN ÄR FARLIG STIRRA EJ IN I STRÅLEN OCH BETRAKTA EJ STRÅLEN MED OPTISKA INSTRUMENT. LP41158-001A
---	--	--	--	--	---



- Manufactured under licence from Dolby Laboratories. "Dolby" and double-D symbol are trademarks of Dolby Laboratories.
- "DTS" and "DTS DIGITAL OUT" are trademarks of Digital Theater Systems, Inc.
- VIDEO Plus+ and PlusCode are registered trademarks of Gemstar Development Corporation. The VIDEO Plus+ system is manufactured under license from Gemstar Development Corporation.
- This product incorporates copyright protection technology that is protected by method claims of certain U.S. patents and other intellectual property rights owned by Macrovision Corporation and other rights owners. Use of this copyright protection technology must be authorized by Macrovision Corporation, and is intended for home and other limited viewing users only unless otherwise authorized by Macrovision Corporation. Reverse engineering or disassembly is prohibited.

The STANDBY/ON \cup /I button does not completely shut off mains power from the unit, but switches operating current on and off. " \cup " shows electrical power standby and "I" shows ON.

When the equipment is installed in a cabinet or a shelf, make sure that it has sufficient space on all sides to allow for ventilation (10 cm or more on both sides, on top and at the rear).

When discarding batteries, environmental problems must be considered and the local rules or laws governing the disposal of these batteries must be followed strictly.

Failure to heed the following precautions may result in damage to the unit, remote control or disc.

1. **DO NOT** place the unit —
 - in an environment prone to extreme temperatures or humidity.
 - in direct sunlight.
 - in a dusty environment.
 - in an environment where strong magnetic fields are generated.
 - on a surface that is unstable or subject to vibration.
2. **DO NOT** block the unit's ventilation openings or holes. (If the ventilation openings or holes are blocked by a newspaper or cloth, etc., the heat may not be able to get out.)
3. **DO NOT** place heavy objects on the unit or remote control.
4. **DO NOT** place anything which might spill on top of the unit or remote control. (If water or liquid is allowed to enter this equipment, fire or electric shock may be caused.)
5. **DO NOT** expose the apparatus to dripping or splashing.
6. **DO NOT** use this equipment in a bathroom or places with water. Also **DO NOT** place any containers filled with water or liquids (such as cosmetics or medicines, flower vases, potted plants, cups, etc.) on top of this unit.
7. **DO NOT** place any naked flame sources, such as lighted candles, on the apparatus.
8. **AVOID** violent shocks to the unit during transport.

MOISTURE CONDENSATION

Moisture in the air will condense on the unit when you move it from a cold place to a warm place, or under extremely humid conditions—just as water droplets form on the surface of a glass filled with cold liquid. In conditions where condensation may occur, disconnect the unit's power plug from the wall and keep it disconnected for a few hours to let the moisture dry, then turn on the unit.

DISCLAIMER OF LIABILITY

JVC shall not be liable for any loss relating to the unit's failure to properly record, store or playback any content (video, audio or otherwise) for any reason whatsoever. Any applicable warranties shall only cover replacement or repair of the effected unit, and shall not apply to recovery or replacement of lost content.

ATTENTION:

- Using a mobile phone in the vicinity of the unit may cause picture vibration on the TV screen or change the screen to a blue back display.
- Some TVs or other appliances generate strong magnetic fields. Do not place such appliances on top of the unit as it may cause picture disturbance.
- If there is a power outage when using the unit, the recorded data may be erased.
- Recorded programmes and data cannot be restored once the disc is damaged.

IMPORTANT

Connection to the mains supply in the United Kingdom. DO NOT cut off the mains plug from this equipment.

If the plug fitted is not suitable for the power points in your home or the cable is too short to reach a power point, then obtain a proper safety approved extension lead/adaptor or consult your dealer.

In the unlikely event of the plug fuse failing be sure to replace the fuse only with an identical approved type, as originally fitted, and to replace the fuse cover. If the fuse fails again consult your nearest JVC dealer.

If nonetheless the mains plug is cut off remove the fuse and dispose of the plug immediately, to avoid a possible shock hazard by inadvertent connection to the mains supply.

If this product is not supplied fitted with a mains plug then follow the instructions given below:

DO NOT make any connection to the Larger Terminal coded E or Green.

The wires in the mains lead are coloured in accordance with the following code:

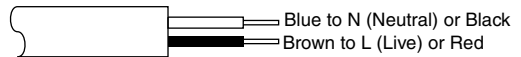

If these colours do not correspond with the terminal identifications of your plug, connect as follows:

Blue wire to terminal coded N (Neutral) or coloured Black.

Brown wire to terminal coded L (Live) or coloured Red.

If in doubt — consult a competent electrician.

HOW TO USE THIS INSTRUCTION MANUAL

- All major sections and subsections are listed in the Table Of Contents on page 5. Use this when searching for information on a specific procedure or feature.
- The Index on pages 11 – 14 illustrates the controls and connections on the front and rear panel, the front display panel and the remote control.
- The list of terms on page 79 lists frequently-used terms, and the number of the page on which they are used or explained in the manual.
- The E mark signals a reference to another page for instructions or related information.
- Operation buttons necessary for the various procedures are clearly indicated through the use of illustrations at the beginning of each major section.

Some Do's And Don'ts On The Safe Use Of Equipment

This equipment has been designed and manufactured to meet international safety standards but, like any electrical equipment, care must be taken if you are to obtain the best results and safety is to be assured.

- DO read the operating instructions before you attempt to use the equipment.
- DO ensure that all electrical connections (including the mains plug, extension leads and interconnections between pieces of equipment) are properly made and in accordance with the manufacturer's instructions. Switch off and withdraw the mains plug when making or changing connections.
- DO consult your dealer if you are ever in doubt about the installation, operation or safety of your equipment.
- DO be careful with glass panels or doors on equipment.
- DON'T continue to operate the equipment if you are in any doubt about it working normally, or if it is damaged in any way—switch off, withdraw the mains plug and consult your dealer.
- DON'T remove any fixed cover as this may expose dangerous voltages.
- DON'T leave equipment switched on when it is unattended unless it is specifically stated that it is designed for unattended operation or has a standby mode. Switch off using the switch on the equipment and make sure that your family knows how to do this. Special arrangements may need to be made for infirm or handicapped people.
- DON'T use equipment such as personal stereos or radios so that you are distracted from the requirements of road safety. It is illegal to watch television whilst driving.
- DON'T listen to headphones at high volume, as such use can permanently damage your hearing.
- DON'T obstruct the ventilation of the equipment, for example with curtains or soft furnishings. Overheating will cause damage and shorten the life of the equipment.
- DON'T use makeshift stands and NEVER fix legs with wood screws—to ensure complete safety always fit the manufacturer's approved stand or legs with the fixings provided according to the instructions.
- DON'T allow electrical equipment to be exposed to rain or moisture.

ABOVE ALL...



- **NEVER** let anyone especially children push anything into holes, slots or any other opening in the case—this could result in a fatal electrical shock;
- **NEVER** guess or take chances with electrical equipment of any kind—it is better to be safe than sorry!

SAFETY FIRST	2	EDITING	54
Safety Precautions	2	DV Dubbing	54
Some Do's And Don'ts On The Safe Use Of Equipment	4	Digital Audio Dubbing	55
DISC INFORMATION	6	Edit From A Camcorder	56
About Discs	6	Edit To Or From Another Recorder	57
INDEX	11	Output/Input Set	58
INSTALLING YOUR NEW UNIT	17	SYSTEM CONNECTIONS	60
Basic Connection	17	Connecting To A Satellite Receiver	60
INITIAL SETTINGS	18	Connecting To A Dolby Digital Decoder Or An Amplifier With Built-in DTS	60
Auto Set Up	18	SUBSIDIARY SETTINGS	61
Preset Download	19	Mode Set	61
Language	21	Remote Control Functions	63
Monitor Set	22	Scan Mode Set	64
BASIC OPERATIONS ON DVD DECK	23	Tray Lock	64
Basic Playback	23	Child Lock	64
Playback Features	24	VIDEO Plus+ System Setup	65
Live Memory Playback	28	Tuner Set	66
Using The On-screen Bar	31	Clock Set	69
Basic Recording	35	Format A Disc	70
Recording Features	36	Finalise A Disc	71
TIMER RECORDING	38	TROUBLESHOOTING	72
VIDEO Plus+ Timer Programming	38	APPENDIX	75
Manual Timer Programming	39	SPECIFICATIONS	78
On-Disc Timer Programming	40	LIST OF TERMS	79
Check, Cancel And Change Programmes	42		
Automatic Satellite Programme Recording	43		
NAVIGATION	44		
Library Database Navigation	44		
Basic Operation Of Original Information	45		
Edit Original Information	47		
Basic Operation Of Play List Information	48		
Edit Play List Information	49		
Edit Library Information	52		
Playback With MP3/JPEG Navigation	53		

About Discs

Recordable/Playable Discs

You can use discs with the following logos for recording and playback.

 <p>DVD-RAM 12 cm: 4.7 GB/9.4 GB 8 cm: 1.4 GB/2.8 GB Ver. 2.0/2x speed Ver. 2.1/1x – 3x speed Ver. 2.2/5x speed</p>	 <p>DVD-RW 12 cm: 4.7 GB 8 cm: 1.4 GB Ver. 1.1/1x – 2x speed (Video mode/VR mode) Ver. 1.2/4x/6x speed (Video mode/VR mode)</p>
 <p>DVD-R 12 cm: 4.7 GB 8 cm: 1.4 GB Ver. 2.0/1x – 4x/8x speed (Video mode) Ver. 2.1/16x speed (Video mode)</p>	

- The above table is based on the information as of February 2005.
- Recording and playback may not be performed depending on the characteristics and condition of the disc used, leading to unsatisfactory results. Using discs manufactured by JVC is recommended since they have been tested to be compatible with this unit.

DVD-RAM Discs

It is only possible to use discs which conform with DVD-RAM standard Version 2.0, 2.1 or 2.2.

- If you use a disc formatted under a different standard version, format it on this unit before use.
- It may not be possible to record, play back, edit or dub a DVD-RAM disc even if it conforms to the standard if it was recorded or edited on the devices from other manufacturers or on a PC, or if it has far too many titles, or if there is very little available capacity remaining on the disc.
- DVD-RAM discs recorded on this unit cannot be played back on an incompatible DVD player.
- It is possible to record copy-once programmes of digital broadcasts only onto 4.7/9.4 GB DVD-RAM discs. (2.8 GB DVD-RAM discs are not compatible)
- This unit does not support discs contained in cartridges. Use the disc after removing it from the cartridge. For details on discs in TYPE2 and TYPE4 (disc removable) cartridge, refer to its instruction manual.
- While recording, it is possible not only to start playback of a programme currently being recorded, but also to watch another programme previously recorded.

DVD-R/RW Discs

It is only possible to use DVD-R discs which conform with DVD-R standard Version 2.0 or 2.1.

It is only possible to use discs which conform with DVD-RW standard Version 1.1 or 1.2. Available in VR mode and Video mode.

When a DVD-R/RW disc (Video mode) is finalised (see pg. 71), it can be played back on a standard DVD player as a DVD VIDEO disc.

When a DVD-RW disc (VR mode) is finalised (see pg. 71), it can be played back on DVD player compatible with the VR mode of DVD-RW discs.

Before finalising—

it is possible to record on unrecorded areas of the disc, edit the disc title and programme titles, and delete programmes.

- It is impossible to record or edit DVD-R/RW discs recorded on other devices even if they have not been finalised.
- It is impossible to overwrite recorded areas of DVD-R discs.
- Available recording capacity does not increase even if a recorded programme is deleted from a DVD-R disc.

After finalising—

After a DVD-R/RW disc (Video mode) has been finalised, it is possible to play back the recorded programmes (video and/or audio) on a standard DVD video player as a DVD VIDEO disc.

- Edited titles are displayed as the “DVD menu” in video mode.
- It is impossible to record, edit or delete the data either in video mode or in VR mode.
- Either in video mode or in VR mode, although the disc can be played back on DVD players from other manufacturers, sometimes it may not be possible to play back depending on the disc and recording conditions.
- It is impossible to record on CD-R/RW or DVD-R discs used for authoring.
- When recording copy-once programmes of digital broadcasts, record in VR mode using CPRM compatible DVD-RW discs.

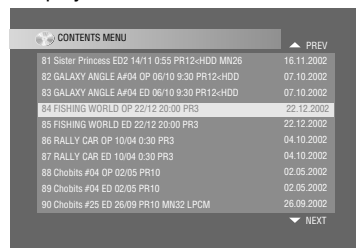







NOTE:

The following may result if you play back a DVD-R disc recorded on another unit.

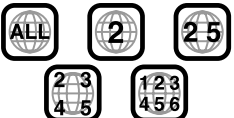
- The disc does not play.
- A mosaic pattern (block noise) appears on the screen.
- Video or audio may be dropped out.
- The unit stops during playback.

Discs For Playback Only

You can use discs with the following logos for playback only.

 <p>DVD VIDEO (example of region code indications)</p> 	<p>Video CD/Super Video CD</p>  
 <p>Audio CD CD-DA files</p>	 <p>CD-R CD-DA/JPEG/ MP3 files</p>
 <p>CD-RW CD-DA/JPEG/ MP3 files</p>	 <p>CD-ROM JPEG/MP3 files</p>

- Playback may not be performed depending on the characteristics and condition of the disc used.
- DTS Audio CDs can also be played back. (An optional DTS decoder is required)
- MP3 and JPEG discs can be played back on this unit only when they have been recorded in the ISO9660 or Joliet format and finalised.
- JPEG files that can be played back on this unit must conform to JFIF/Baseline process, and the maximum resolution of a JPEG file is 2,812 pixels in width and 2,112 pixels in height.
- CD-R/RW discs recorded in music CD format need to be finalised to play back on this unit.
- Operation and audio quality of this unit are not guaranteed for discs that do not conform to the Compact Disc specification (CD-DA).
Before you play back a CD, check for the CD logo and read the notes on the package to confirm that it conforms to the Compact Disc specification.
- Depending on the intentions of the author of the software, recording conditions of DVD discs and Video CD/SVCD discs may be restricted. Since this unit plays back discs according to the intentions of the author of the software as indicated on the disc, some functions may not operate as commanded.
- When switching from the first layer to the second layer of double-layered DVD VIDEO discs, the image and sound may be momentarily distorted. This is not a malfunction.
- DVD-AUDIO discs compatible with DVD video players can be played.
- Super Audio CDs (SACD) compatible with conventional CD players can be played.
- It is possible to play back finalised +R/+RW (Video mode only) discs. "DVD" lights on the front display panel when a +R/+RW disc is loaded.
However, the use of +R double layer disc on this unit may not be recommended.

Unplayable Discs

The unit may not be able to play back or it may take some time to read a disc depending on the recording status or condition of the disc, or if the disc is scratched, dirty or warped. In addition, do not attempt to play back discs in unusual shapes (heart-shaped, octagonal, or other forms). If such discs are accidentally played back, it may cause noise that can lead to speaker damage.

- CD-ROM discs (including PHOTO-CD and CD-G)
- Discs recorded in Packet Write (UDF) format
- 1.3 GB double density CDs (DDCD)
- High density CDs (HDCD)

The following discs also cannot be played back.

- Discs of a region number other than "2"
- DVD-RAM (2.6 GB/5.2 GB)
- DVD-RAM (TYPE1)

Caution for DualDisc playback

The Non-DVD side of a "DualDisc" does not comply with the "Compact Disc Digital Audio" standard. Therefore, the use of Non-DVD side of a DualDisc on this product may not be recommended.

Region Number

The world is divided into 6 regions for DVD VIDEO discs. DVD VIDEO discs are assigned a region number to indicate which region they may be played back in. A disc cannot be played back on this unit unless the region number of the disc matches that of the unit. The region number for this unit is "2". Only discs whose region number includes "2" or "ALL" can be played back such as shown below.

Examples of DVD VIDEO labels which can be played back using this unit.



Marks of discs in this instruction manual

	Allows operation with a DVD-RAM disc.		Allows operation with a Video CD/Super Video CD (SVCD) disc.
	Allows operation with a DVD-R disc.		Allows operation with an Audio CD disc.
	Allows operation with a DVD-RW disc.		Allows operation with a disc including MP3 files.
	Allows operation with a DVD VIDEO disc.		Allows operation with a disc including JPEG files.

Recording Medium And Format

DVD-RAM

- Recording and erasing can be performed as many times as possible on a disc.
- Editing can be performed after recording, such as deleting unwanted parts.
- While recording, it is possible not only to start playback of a programme currently being recorded, but also to watch another programme previously recorded.

DVD-RW (VR mode)

- Recording and erasing can be performed as many times as possible on a disc.
- Editing can be performed after recording, such as deleting unwanted parts.

DVD-RW (Video mode)

- Can be played back on other DVD players after finalising.
- New recording can be performed by erasing all the data on a disc once played back.

DVD-R

- Can be played back on other DVD players after finalising.
- Suitable when keeping a recorded disc for a long time.

File Structure Of Discs

DVD VIDEO

Typically, DVD VIDEO discs are made up of larger units called "titles". Each title has a number (title number) that can be used to select desired titles. Titles are further divided into units called "chapters". Each chapter has a number (chapter number) that can also be used to select desired chapters. Note that some discs are not divided into titles and chapters.

When you record a programme on a DVD-RAM/RW (VR mode) disc

A single recording session results in a single title. In addition, chapter marks are automatically inserted when recording is paused. It is also possible to insert chapter marks at desired locations during playback. (pg. 26)

When you record a programme on a DVD-R/RW (Video mode) disc

A single recording session results in a single title. In addition, chapter marks are automatically inserted when recording is paused. It is possible to insert chapter marks at desired locations during playback. Once the disc has been finalised, these chapter marks are deleted and new chapter marks are assigned automatically approximately every 5 minutes.

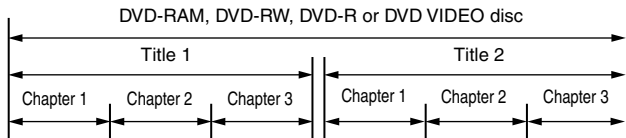

- In Video mode, even before finalising, it is impossible to perform editing operations other than changing the disc name and/or title names and deleting programmes and/or titles.
- After finalising, it is impossible to perform editing operations.

Audio CD/Video CD/SVCD

Typically, Audio CD discs are divided into separate tracks each containing one song. Each track is assigned a number. For example, the third track is Track 3. The same is true for Video CD/SVCD discs.

However, some discs are not divided into tracks.

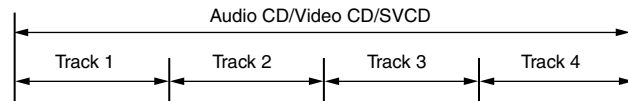

JPEG/MP3 Disc (CD-R/RW/ROM)

MP3/JPEG files put in directories nested in several levels on a disc will be organized as if they were put in single level directories (groups) by the MP3/JPEG Navigation of this unit. (pg. 53)

File structure of a disc before starting the MP3/JPEG Navigation

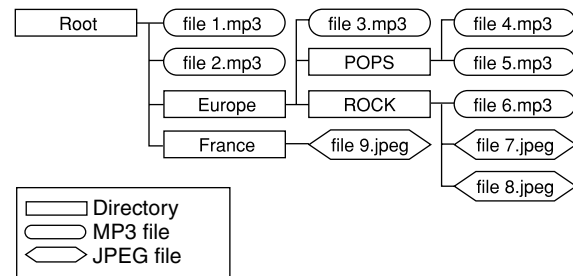

File structure of the disc after starting the MP3/JPEG Navigation

Files are automatically grouped as follows and displayed on the MP3/JPEG Navigation screen. Data is displayed in the alphabetical order of file name. Files are grouped based on roots.

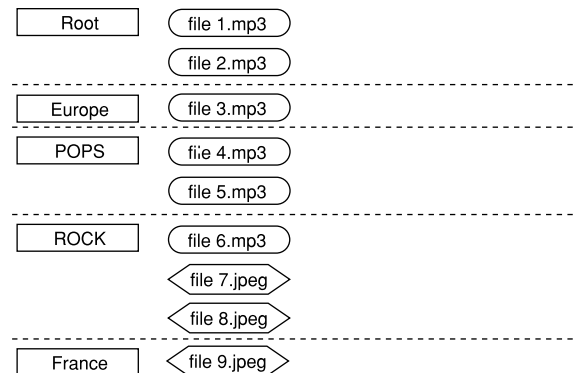

- This unit can recognise up to 9 hierarchies including directories and files.

Also, it can recognise up to 250 files in each group, and up to 99 groups on a disc.





NOTES:

- **Video CD/SVCD discs that support Playback Control (PBC)**
The contents of a disc are recorded into several hierarchies, and played back according to the instructions on the screen while navigating through the hierarchies. It is also possible to playback recorded tracks consecutively without activating the PBC function even when playing a PBC-compatible disc. (pg. 27)
- **Regarding the contents recorded on discs**
Some files may not be played back depending on the file types and other factors.



DVD VIDEO Marks

Sometimes marks are printed on a DVD disc and/or on its packaging to indicate information regarding the contents and functions of the disc. Check the marks indicating the contents and functions of the disc. Note, however, that in some cases a disc may not include a mark even for a function it supports.

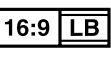
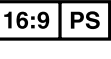
Marks related to video

	Number of subtitles		Number of angles
	Recorded under the standard 4:3 aspect ratio		Screen includes black bands at the top and the bottom of image which has a standard 4:3 aspect ratio (letter box)
	Video playback is in Wide video mode (16:9) on wide televisions, but in letter box on televisions with standard 4:3 aspect ratio.		
	Video playback is in Wide video mode (16:9) on wide televisions, but pan and scan is used on televisions with standard 4:3 aspect ratio (either the left or right side of the image is cut-out).		

Marks related to audio

	Number of audio tracks
	Dolby Digital mark It has been developed by Dolby Laboratories as a digital surround system.
	DTS (Digital Theater Systems) You can enjoy DTS audio if you connect an amplifier with a built-in DTS decoder to the DIGITAL OUT connector of the unit.

Placing A Disc

Opening the disc tray

Press  to open the disc tray.

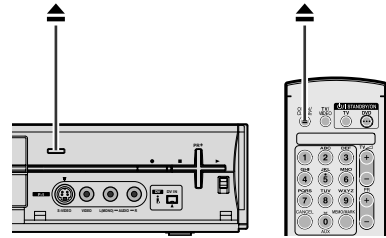

- Pressing the button again closes the disc tray.
- Use the button to open and close the disc tray.
- Do not block the disc tray with your hand while it is opening or closing as this may result in hardware failure.
- Do not place unplayable discs or any object other than a disc on the disc tray.
- Do not press down strongly on the disc tray or place any heavy objects on it.

Discs without cartridges

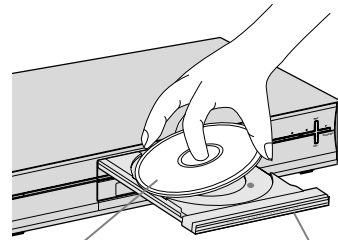

Label side facing up

Disc tray

Place the disc on the disc tray with the label side facing up. Since disc size changes depending on the disc to be played back, be sure to correctly align the disc with the grooves for its size. If the disc is not in its groove, it may be scratched or otherwise damaged. To insert an 8 cm disc, place it according to the inner groove.

DVD-RAM discs contained in cartridges

Double-sided discs:

Remove the disc from the cartridge. Align the disc with the grooves on the disc tray as shown in the illustration and insert with the side you wish to play back or record facing down. If you insert the disc with "Side A" facing down, programmes are recorded on side A.

Single-sided discs:

Remove the disc from the cartridge. Align the disc with the grooves on the disc tray as shown in the illustration and insert with the label side facing up.

Care And Handling Of Discs

How to handle discs

When handling a disc, do not touch the surface of the disc. Since discs are made of plastic, they are easily damaged. If a disc gets dirty, dusty, scratched or warped, the images and sound will not be picked up correctly, and such a disc may cause the unit to malfunction.

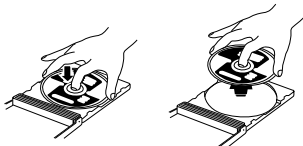

Label side:

Do not damage the label side, stick paper to or use any adhesives on its surface.

Recording side:

Make sure that discs are not scratched and dirty on the recording side before use. Scratches and dirt on the recording side of a disc may hinder proper playback and recording. Also be careful that a DVD-RAM disc may get scratched or dirty when removed from cartridge then put back in after use.

Storage

Make sure that discs are kept in their cases. If discs are piled on top of one another without their protective cases, they can be damaged. Do not put discs in a location where they may be exposed to direct sunlight, or in a place where the humidity or temperature is high. Avoid leaving discs in your car!

Maintenance of discs:

If there are fingerprints or other dirt adhering to a disc, wipe with a soft dry cloth, moving from the centre outwards.

If a disc is difficult to clean, wipe with a cloth moistened with water. Never use record cleaners, petrol, alcohol or any anti-static agents.









CAUTION:

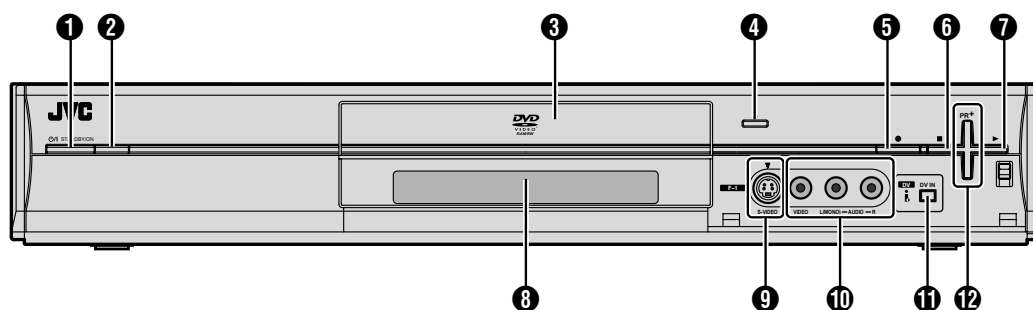

Sometimes during playback, noise may appear or images may be garbled. This is sometimes due to the disc. (It may not be up to industry standards.)

These symptoms are caused by the discs, not by the malfunction of the unit.

Front View



- ❶ Standby/On Button (STANDBY/ON )
- ❷ Infrared Beam Receiving Window
- ❸ Disc tray
- ❹ Eject Button () [pg. 9](#)
- ❺ Record Button () [pg. 35](#)
- ❻ Stop Button () [pg. 23](#)
- ❼ Play Button () [pg. 23](#)

- ❸ Front Display Panel [pg. 13](#)
- ❹ S-video Input Connector [S-VIDEO] [pg. 56](#)
- ❷ Video/Audio Input Connectors [VIDEO/AUDIO (L(MONO)/R)] [pg. 56](#)
- ❹ DV Input connector [DV IN ()] [pg. 54](#)
 *  (i.Link) refers to the IEEE1394-1995 industry specification and extensions thereof. The  logo is used for products compliant with the i.Link standard.
- ❷ Programme Buttons (PR +/-) [pg. 35](#)

To access covered connectors, press PUSH-OPEN to open the cover.

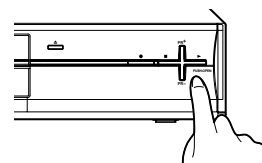

Rear View

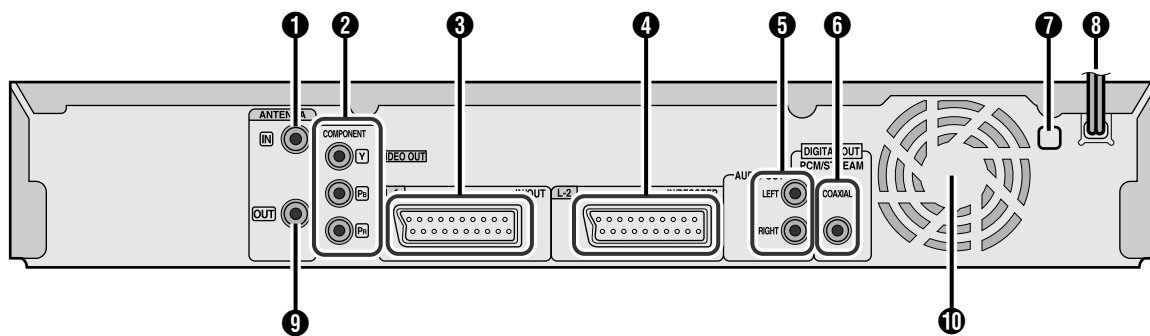

- ❶ Antenna Input Connector [ANTENNA IN] [pg. 17](#)
 - ❷ Component Video Output Connectors [COMPONENT VIDEO OUT (Y/Pb/Pr)] [pg. 17](#)
 - ❸ L-1 Input/Output Connector [L-1 IN/OUT] [pg. 17, 57, 58, 60, 61](#)
 - ❹ L-2 Input/Decoder* Connector [L-2 IN/DECODER] [pg. 57, 58, 60, 61](#)
- * The decoder function of this unit is not available in the U.K.
- ❺ Audio Output Connector [AUDIO OUT LEFT/RIGHT] [pg. 17](#)
 - ❻ Digital Audio Output Connector [DIGITAL OUT (COAXIAL)] [pg. 55, 61](#)
 - ❼ Region Number
 - ❽ AC Power Cord
 - ❾ Antenna Output Connector [ANTENNA OUT] [pg. 17](#)

❿ Cooling Fan

- This prevents the temperature from rising inside the unit. Do not remove it.
- Install the unit so as not to block the area around the fan.
- The unit may become hot when it is turned off, as the cooling fan on the rear of the unit is not activated. However, the cooling fan may be activated in the following cases;
 - In the Automatic Satellite Programme Recording standby mode ([pg. 43](#)), slightly before the starting time of VPS/PDC recording ([pg. 39](#)).
 - If you connect the decoder or satellite receiver to [L-2 IN/DECODER], and if “L-2 SELECT” is set to “DECODER”, “SAT VIDEO/RGB” or “SAT S-VIDEO/RGB”. ([pg. 59](#))
 - When “JUST CLOCK” is set to “ON” ([pg. 69](#)) (Set “JUST CLOCK” to “OFF” if you mind the noise of the fan.)

Front Display Panel

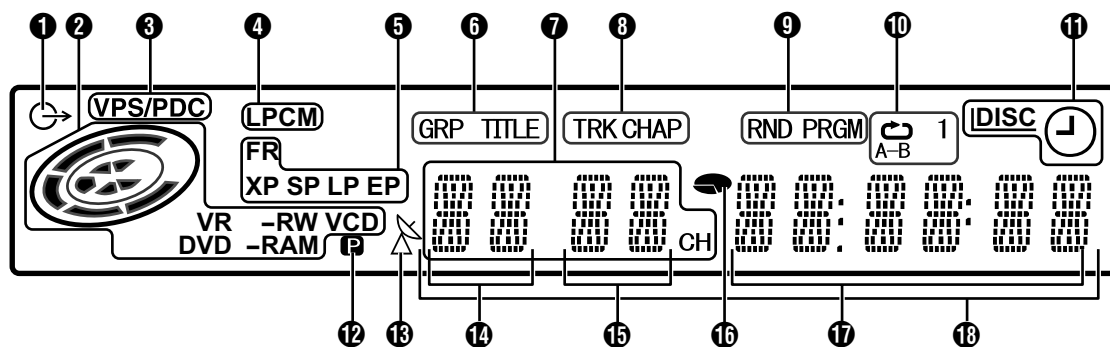
**1 Video Indicator (G)** [pg. 23](#)

Lights when video mode is selected by pressing TV **G**.

2 Disc Type Indicator

When a disc is loaded, the type of the disc is indicated.

Disc Status Indicator

When a disc is running, the disc marks rotate.

During High-Speed Search:

Rotate faster than normal playback.

During Slow Motion:

Rotate slower than normal playback.

While recording:

Inner red ring lights in the same way as normal playback.

During Instant Timer Recording (ITR), inner red ring slowly blinks.

While paused:

Disc marks blink when either recording or playing back.

While stopped: Disc marks all light.

While resume stopped: Disc marks all blink.

While the disc tray opened: Disc marks all light out.

No disc on the disc tray: Disc marks all light out.

VR Mode Indicator (VR) [pg. 70](#)

Lights when a DVD-RW disc is formatted in VR mode.

3 VPS/PDC Indicator [pg. 39](#)

Lights when checking if the station being received transmits a VPS/PDC signal.

4 Linear PCM Indicator (LPCM)

Lights when "XP MODE REC AUDIO" is set to "LINEAR PCM" ([pg. 62](#)) for recording with DVD-RAM, DVD-R and DVD-RW discs, and when Linear PCM audio is played.

5 Recording Mode Indicator (XP/SP/LP/EP/FR) [pg. 35](#)

Blinks when recording mode is being set.

While "FR" is blinking, the left 3 digits of the Multi Display (**14** **15**) indicate setting values ranging from "60" to "480". After the value has been set, only "FR" lights.

6 Group/Title Indicator (GRP/TITLE)

"GRP" or "TITLE" lights depending on a disc loaded while the left 2 digits of the Multi Display (**14**) indicate the numbers explained below.

"GRP": Total number of groups or group number being played back are displayed on the Multi Display.

"TITLE": Total number of titles or title number being played back are displayed on the Multi Display.

7 Channel Indicator

Indicates the channel received.

8 Track/Chapter Indicator (TRK/CHAP)

"TRK" or "CHAP" lights depending on a disc loaded while the 3rd and 4th digits from the left of the Multi Display (**15**) indicate the numbers explained below.

"TRK": Total number of tracks or track number being played back are displayed on the Multi Display.

"CHAP": Chapter number being played back are displayed on the Multi Display.

9 Random/Programme Playback Mode Indicator (RND/PRGM) [pg. 34](#)

"RND": Lights when Random Playback mode is set.

"PROG": Lights when Programme Playback mode is set.

10 Repeat Mode Indicator (A-B/1) [pg. 31, 32](#)

Select Repeat Playback mode on the on-screen bar.

"A-B": Whole disc is played back repeatedly.

"1": A single title/chapter/track is played back repeatedly.

"A-B": The selected part (A-B) is played back repeatedly.

No display: Repeat Playback mode is off.

11 DISC Timer Indicator [pg. 40](#)

DISC: Lights when a disc set up for On-Disc Timer Programming is loaded.

⊖: Lights when timer recording other than On-Disc Timer Programming is on stand-by or being executed.

DISC ⊖: Lights when On-Disc Timer Programming is on stand-by or being executed.

⚡: Blinks quickly if you press **TIMER** ⊖ in the following cases;

- Disc is not loaded.
- Clock has not been set.
- There is no programme setting.

12 Video Output Indicator (P) [pg. 64](#)

No display: Indicates that interlace mode is engaged.

P: Indicates that progressive mode is engaged.

(Example) P lights when video output mode is in progressive mode.

13 Automatic Satellite Programme Recording Indicator [pg. 43](#)

Lights when the unit is in the Auto Satellite Programme Recording standby mode.

14 Group/Title Number Display**15 Track/Chapter Number Display****16 Remaining Time/Elapsed Time Display** [pg. 26, 36](#)

Lights when remaining time of DVD-RAM, DVD-R and DVD-RW discs is displayed, and lights out when elapsed time is displayed.

The right 6 digits of the Multi Display (**17**) indicate elapsed or remaining time of each track.

No display: Indicates elapsed time of the disc.

Displayed: Indicates remaining time of the disc.

17 Remaining Time/Elapsed Time Display [pg. 26, 36](#)**18 Multi Display**

Displays clock, received channel, elapsed time, and remaining time.

Also displays status of the unit.

Remote Control

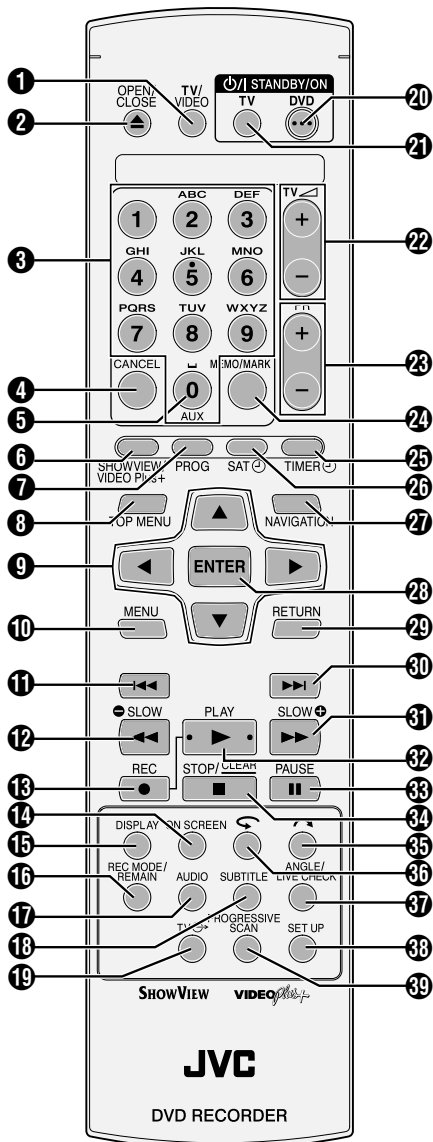

- 1 TV/VIDEO Button
For switching the input of a JVC TV.
- 2 Open/Close Button (▲)
- 3 Number Keys pg. 24, 33, 34
- 4 Cancel Button (CANCEL) pg. 34
- 5 Auxiliary Button (AUX)
- 6 SHOWVIEW Button
VIDEO Plus+ Button pg. 38
- 7 Programme Button (PROG) pg. 39
- 8 Top Menu Button (TOP MENU) pg. 24
- 9 Selection Keys (▲▼◀▶)
- 10 Menu Button (MENU) pg. 24
- 11 Reverse Skip Button (◀◀) pg. 24, 27, 30, 34
- 12 Reverse Search Button (◀◀) pg. 24, 30
Reverse Slow Button (SLOW -) pg. 25
- 13 Record Button (●) pg. 35, 36
- 14 On-Screen Button (ON SCREEN) pg. 31
- 15 Display Button (DISPLAY) pg. 26, 36
- 16 Recording Mode Button (REC MODE) pg. 35, 43
Remain Button (REMAIN) pg. 26, 36

- 17 Audio Button (AUDIO) pg. 27
- 18 Subtitle Button (SUBTITLE) pg. 26
- 19 TV/Video Mode Select Button (TV ↔) pg. 23
For switching the TV input to video mode (or connected external mode).
- 20 DVD STANDBY/ON Button (DVD ⏻/⏻) pg. 41
- 21 TV STANDBY/ON Button (TV ⏻/⏻)
For turning on/off the power of a JVC TV.
- 22 TV Volume Buttons (TV ▲/▼)
For adjusting the volume of a JVC TV.
- 23 Programme Buttons (PR +/-) pg. 35,
- 24 Memo Button (MEMO) pg. 45
Mark Button (MARK) pg. 26
- 25 Timer Button (TIMER) pg. 38, 39
- 26 Automatic Satellite Programme Recording Button (SAT) pg. 43
- 27 Navigation Button (NAVIGATION) pg. 44
- 28 Enter Button (ENTER)
- 29 Return Button (RETURN) pg. 27
- 30 Forward Skip Button (▶▶) pg. 24, 27, 30, 34
- 31 Forward Search Button (▶▶) pg. 24, 30
Forward Slow Button (SLOW +) pg. 25
- 32 Play Button (▶) pg. 23, 24, 29
- 33 Pause Button (⏸) pg. 23, 30
- 34 Stop Button (■) pg. 23
Clear Button (CLEAR) pg. 33
- 35 Skip Search Button (↶) pg. 25, 30
- 36 One Touch Replay Button (↶) pg. 25, 30
- 37 Angle Button (ANGLE) pg. 26
Live Check Button (LIVE CHECK) pg. 28, 30
- 38 Set Up Button (SET UP) pg. 61
- 39 Progressive Scan Button (PROGRESSIVE SCAN) pg. 33, 64

How To Use

Before use, insert two AA size batteries into the remote control with the polarity (+) and (-) matched correctly as indicated on the battery compartment or on the lid.

- Point the remote control toward the receiving window.
- The maximum operating distance of the remote control is about 8 m.

NOTE:

If the remote control doesn't work properly, remove its batteries, wait a short time, replace the batteries and then try again.

Check Contents

CHECK ALL THE CONTENTS SHOWN BELOW

DVD Video Recorder

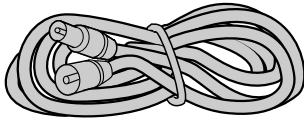

RF Cable

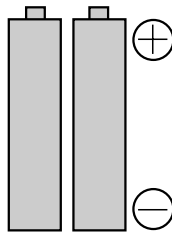

"AA" Batteries (x 2)

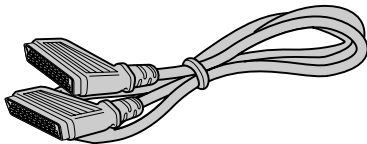

21-pin SCART Cable

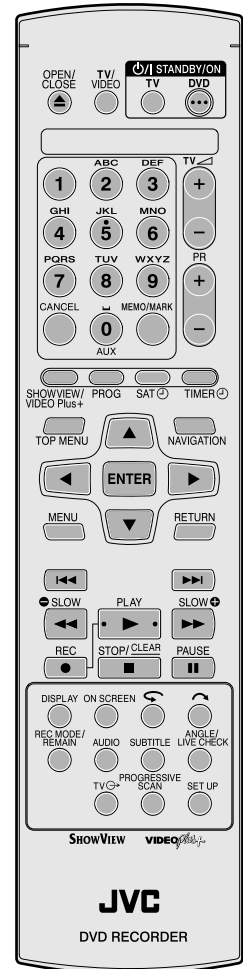

Infrared Remote Control Unit

► You are now ready to install your unit. (pg. 17)

On-Screen Display

When **ON SCREEN** on the remote control is pressed, various operational indicators appear on the TV screen. To clear the operational indicators, press **ON SCREEN** twice.

When playing back a recorded title

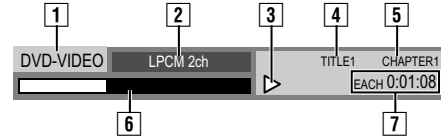

- 1 Disc type
- 2 Audio mode
- 3 Current status (playback)
- 4 Playback title number
- 5 Playback chapter number
- 6 Current playback point
- 7 Elapsed playing time

When recording

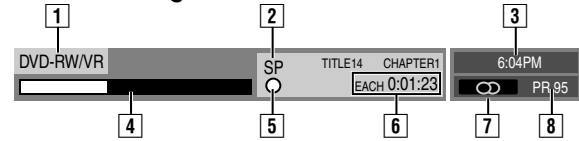

- 1 Disc type
- 2 Recording mode
- 3 Current time
- 4 Recording point
- 5 Current status (recording)
- 6 Elapsed recording time
- 7 Audio mode
- 8 Recording channel number

When pressing REC MODE:

(Appears for eight seconds.)

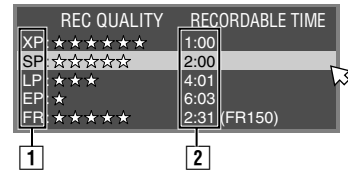

- 1 Recording mode
- 2 Remaining disc time for each recording speed

During Instant Timer Recording (ITR)

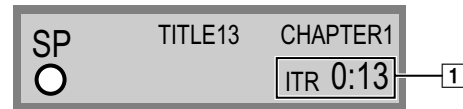

- 1 Record remaining time

When using Live Memory playback

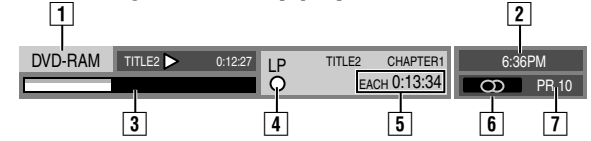

- 1 Disc type
- 2 Current time
- 3 Bar meter for recording/playback
- 4 Recording mode
- 5 Current playback time/Elapsed recording time
- 6 Audio mode
- 7 Recording channel number

DV Dubbing

When capturing images from the external DV equipment

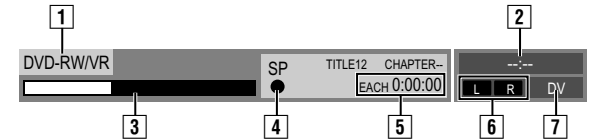

- 1 Disc type
- 2 Current time
- 3 Current recording point
- 4 Current status (recording)
- 5 Elapsed recording time
- 6 Sound mode
- 7 Recording channel (DV input)

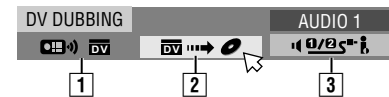

- 1 Displays when remote control is set to DV control mode.
- 2 Auto capture button
- 3 Sound monitor switch

Basic Connection

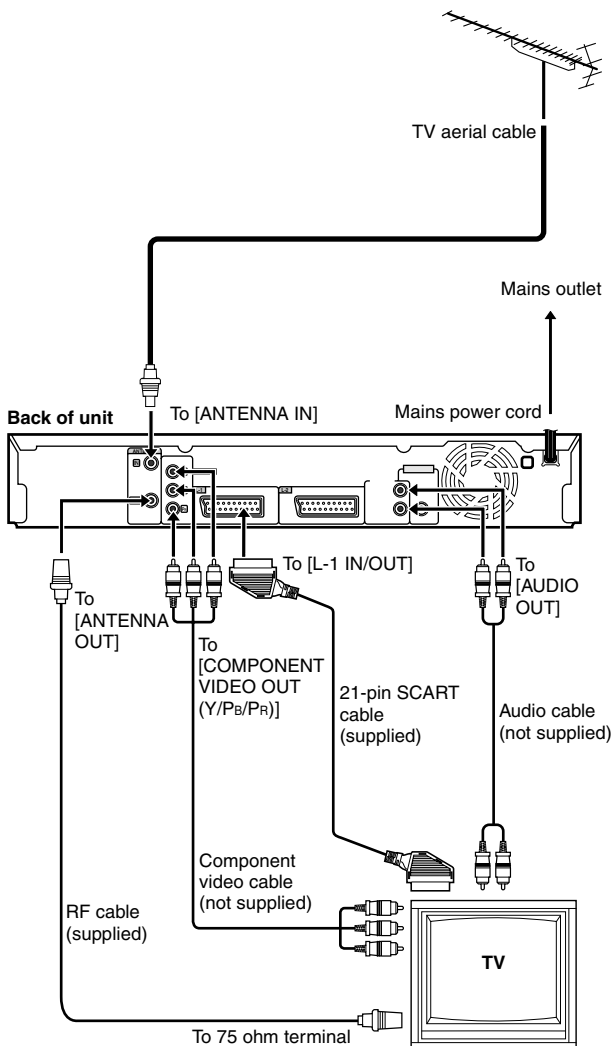

It's essential that your unit be properly connected.

ATTENTION:

- Your TV must have a 21-pin AV input connector (SCART) for the basic connection to the unit.
- Connect the AC plug only after all connections to the TV has been completed.

THESE STEPS MUST BE COMPLETED BEFORE ANY VIDEO OPERATION CAN BE PERFORMED.

- 1 Place the unit on a stable, horizontal surface.
- 2 Connect the unit to a TV depending on the TV and cables you use.

■ **Basic Connection**

To connect to a TV with 21-pin SCART input connector —

- 1 Disconnect the TV aerial cable from the TV.
- 2 Connect the TV aerial cable to the [ANTENNA IN] connector on the rear panel of the unit.
- 3 Connect the [ANTENNA OUT] connector on the rear panel of the unit and the TV's aerial connector with the supplied RF cable.
- 4 Connect the [L-1 IN/OUT] connector on the rear panel of the unit and the TV's 21-pin SCART connector with a supplied 21-pin SCART cable.
 - The [L-1 IN/OUT] connector accepts and delivers either a composite signal (regular video signal), Y/C signal or RGB signal.
 - Set your TV to the VIDEO, Y/C, or RGB mode according to the type of your TV's SCART connector.

■ **Component Video Connection**

To connect to TV's component video input connectors —

- 1 Perform steps 1 – 3 of "Basic Connection".
- 2 Connect the unit's [COMPONENT VIDEO OUT (Y/Pb/Pr)] connectors to the TV's component video input connectors.
- 3 Connect the unit's [AUDIO OUT] connectors to the TV's AUDIO input connectors.
 - You can obtain high-quality component video pictures.
 - If your TV is not stereo-capable, use the unit's [AUDIO OUT] connectors to connect to an audio amplifier for Hi-Fi stereo sound reproduction.
 - By using the component video connection, you can view the images in the progressive mode. For switching to the progressive mode, refer to "Scan Mode Set" (pg. 64).

NOTE:

Select an appropriate option of "L-1 OUTPUT" as follows (pg. 58):

When your TV's SCART connector accepts:	Set "L-1 OUTPUT" to:
Composite signals	"SCART VIDEO"
Y/C signal (separated luminance (brightness) and chrominance (colour) signals)	"SCART S-VIDEO"
RGB signal	"SCART RGB"
Component video signal	"COMPONENT"

When the setting selected is not in accordance with the TV connected and depending on the type of appliance connected to the unit, the correct picture will not appear.

- 3 Plug the end of the mains power cord into a mains outlet.
 - "PLEASE" and "WAIT" blink alternately on the front display panel when the AC plug of the mains power cord is connected into a mains outlet. And it takes approximately 30 seconds for the unit to be turned on. This is not a malfunction.

If you possess a satellite receiver, refer to "Connecting To A Satellite Receiver" as well. (pg. 60)

Auto Set Up

Auto Channel Set/Auto Clock Set/Auto Guide Programme Number Set

After the \odot/I button on the unit (or DVD \odot/I on the remote control) is pressed for the first time to turn on the unit, the Auto Set Up function sets the tuner channels, clock and Guide Programme numbers automatically.

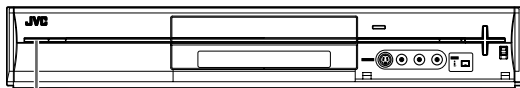

\odot/I

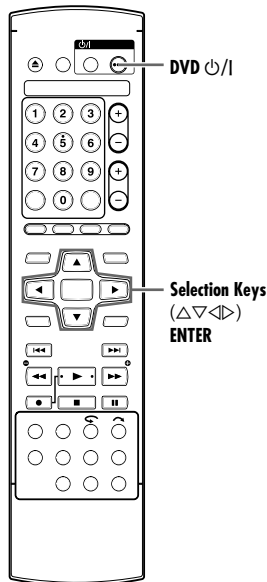

ATTENTION:

“AUTO” blinks on the front display panel; do NOT press any button on the unit or remote control until the front display panel shows clock time, “PR1” or “-:-:-” as illustrated on page 20.

- When you have connected the unit to a TV offering T-V Link via a fully-wired 21-pin SCART cable (pg. 17) and the TV is turned on, the unit automatically performs the Preset Download (pg. 19) even if you select “AUTO SET” for Auto Set Up function.

ATTENTION:

Once you have performed “Auto Set Up”, even if the unit’s memory backup has expired, all the stored stations and their Guide Programme numbers remain in the unit’s memory and the unit will not perform “Auto Set Up” again. Perform clock set manually after turning on the unit. (pg. 69)

If you have moved to a different area, perform each setting as required.

- Tuner setting (pg. 66)
- Clock setting (pg. 69)

If a new station starts broadcasting in your area, perform tuner setting. (pg. 66)

NOTES:

- In areas where no TV station transmits a PDC (Programme Delivery Control) signal, the unit can perform neither Auto Clock Set nor Auto Guide Programme Number Set.
- If there is a power cut, or if you press \odot/I or **SET UP** while “Auto Set Up” is in progress, “Auto Set Up” will be interrupted. Be sure to turn off the unit power once and try again from step 1.
- Auto Clock Set may not function properly depending on the reception condition.

After “Auto Set Up” is completed, perform “Monitor Set” on page 22.

Before starting, make sure of the following:

- The TV aerial cable should be connected to the unit.
- The unit’s mains power cord should be connected to a mains outlet.
- Turn on the TV and select an input mode such as EXT1.

1 Press \odot/I on the unit or DVD \odot/I on the remote control to turn on the unit. The AUTO SET/T-V LINK display appears on the TV screen.

2 Press **selection keys** to select “AUTO SET”, then press **ENTER**.

- Auto Channel Set is performed.
- When Auto Channel Set is completed, “SCAN COMPLETED” appears on the TV screen.

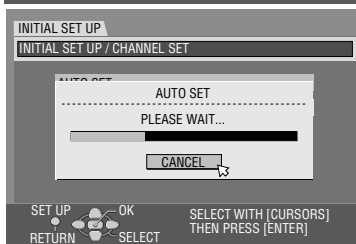
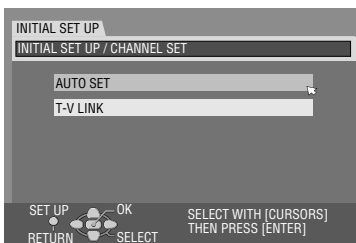

Preset Download

Auto Channel Set by Downloading from TV/Auto Clock Set/Auto Guide Programme Number Set

ATTENTION:

You can use this function only with a TV offering T-V Link, etc.* Be sure to use a fully-wired 21-pin SCART cable.

* Compatible with TVs offering T-V Link, EasyLink, Megalagic, SMARTLINK, Q-Link or DATA LOGIC via a fully-wired 21-pin SCART cable. The degree of compatibility and available functions may differ by system.

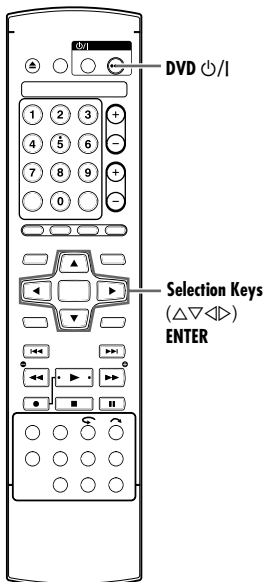

If you have connected the unit to your TV via a 21-pin SCART cable (see pg. 17), the unit will automatically perform Preset Download instead of the “Auto Set Up” in step 2 on page 18. After downloading, the unit sets the clock and Guide Programme numbers automatically.

- 1 Press **⏻/I** on the unit or **DVD ⏻/I** on the remote control to turn on the unit. The AUTO SET/T-V LINK display appears on the TV screen.
- 2 Press **selection keys** to select “T-V LINK”, then press **ENTER** for confirmation.
 - T-V LINK setting is performed.
 - When T-V LINK setting is completed, “SCAN COMPLETED” appears on the TV screen for about 5 seconds, then the normal screen resumes.

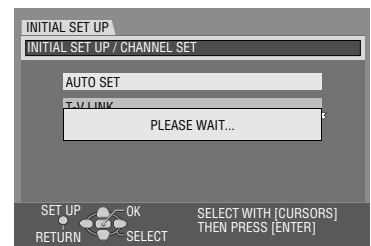
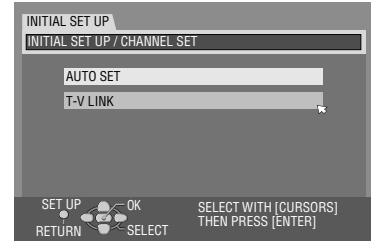

ATTENTION:

Preset positions on the front display panel increase from “PR1”...“PR3”...; do NOT press any button on the unit or remote control until the front display panel shows clock time, “PR1” or “-:-:-” as illustrated on page 20.

- If you press any button on the unit or remote control while downloading is in progress, it will be interrupted.

NOTES:

- For details, refer to the instruction manual of your TV.
- In areas where no TV station transmits a PDC (Programme Delivery Control) signal, the unit can perform neither Auto Clock Set nor Auto Guide Programme Number Set.
- If there is a power cut, or if you press **⏻/I** or **SET UP** while downloading or set up is in progress, it will be interrupted. Be sure to turn off the unit power once and try again from the beginning.
- Auto Clock Set may not function properly depending on the reception condition.
- On this unit, the characters available for station names (ID) are A–Z, 0–9, –, *, + and _ (space). Some names of downloaded stations may differ from those of your TV. (see pg. 68)

After “Preset Download” is completed, perform “Monitor Set” on page 22.

Results Of Auto Set Up/Preset Download Appearing On The Front Display Panel

If both Auto Channel Set and Auto Clock Set have been performed successfully, the correct current time is displayed.

PR 1 20:00

Turn on the TV and select an input mode such as EXT1, then make sure that all necessary stations have been stored in the unit's memory by using the **PR +/-** button(s).

- If station names (ID – pg. 76) have also been stored in the unit's memory, the station name will be displayed at the top right corner of the TV screen for about 5 seconds when the unit is tuned to a different station.
- If you want to set the tuner manually such as to add or skip channels, to change channel positions, or to set or change station names, see pages 67 and 68.

If Auto Channel Set has succeeded but Auto Clock Set has not, "PR1" (channel position) is displayed.

PR 1 - - - -

OR

If both Auto Channel Set and Auto Clock Set have failed, "--:--" is displayed.

- 1 Turn on the TV and select an input mode such as EXT1, then make sure that all necessary stations have been stored in the unit's memory by using the **PR +/-** button(s).
 - If station names (ID – pg. 76) have also been stored in the unit's memory, the station name will be displayed at the top right corner of the TV screen for about 5 seconds when the unit is tuned to a different station.
 - If you want to set the tuner manually such as to add or skip channels, to change channel positions, or to set or change station names, see pages 67 and 68.
- 2 Perform "Clock Set" (pg. 69).

ATTENTION:

After making sure the cables are connected properly, turn off the unit's power once, then turn the unit's power back on again. Perform "Auto Set Up" (pg. 18) or "Preset Download" (pg. 19) again.

IMPORTANT:

- To check if the Guide Programme numbers have been set correctly, perform the VIDEO Plus+ Timer Programming. (pg. 38)
- In certain reception conditions, station names may not be stored correctly, and Auto Guide Programme Number Set may not work properly. If the Guide Programme numbers are not set properly when you timer record a TV programme using the VIDEO Plus+ system, the unit will record a TV programme of a different station. When programming the timer using the VIDEO Plus+ system, be sure to check the desired channel is selected correctly. (pg. 38)
- Your unit memorises all detected stations even if reception of some of them is poor. You can delete those stations with an unacceptable picture. (pg. 67, "Delete A Channel")

INFORMATION

Just Clock

Your unit is equipped with the Just Clock function which provides accurate time keeping through automatic adjustments at regular intervals, by reading data from a PDC signal. If you want to take advantage of this function, simply set "JUST CLOCK" to "ON". (pg. 69)

If you have any difficulty with the above procedures call the JVC Customer Service Hot Line on 0870 330 5000.

T-V Link Functions

When you connect the unit to your TV via a fully-wired 21-pin SCART cable (pg. 17), the following functions are available. You can use these functions only with a TV offering T-V Link, etc.*

For details, refer to the instruction manual of your TV.

* Compatible with TVs offering T-V Link, EasyLink, Megalogic, SMARTLINK, Q-Link or DATA LOGIC via a fully-wired 21-pin SCART cable. The degree of compatibility and available functions may differ by system.

TV Auto Power On

The TV will turn on and be set to an input mode such as EXT1 automatically whenever you start playback.

For details, refer to the instruction manual of your TV.

Unit Auto Standby

You can use your TV's remote control to turn off the unit.

For details, refer to the instruction manual of your TV.

Direct Rec

You can easily start recording the programme that you are watching on your TV. When you use this function, set "DIRECT REC" to "ON". (pg. 62)

Language

- Turn on the unit.
- Turn on the TV and select an input mode such as EXT1.

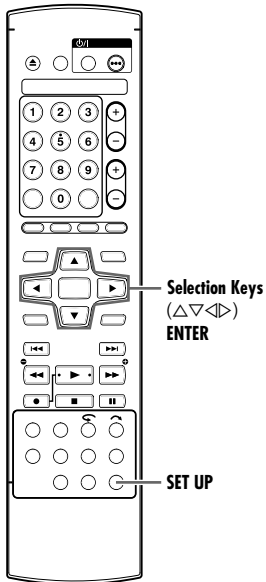

Menu/Audio/Subtitle Language Set

Some DVD discs contain the DVD menu display, audio and subtitles in multiple languages. With these discs, you can set the default language as you like.

- The procedure shows how to set “MENU LANGUAGE” as an example.

- 1 Press **SET UP** to access the Main Menu screen.
- 2 Press **selection keys** to select “DVD SET UP”, then press **ENTER** for confirmation.
- 3 Press **selection keys** to select “LANGUAGE SET”, then press **ENTER** for confirmation.
- 4 Press **selection keys** to select “MENU LANGUAGE”, then press **ENTER** for confirmation.
- 5 Press **selection keys** to select your desired language, then press **ENTER**.
 - See “Language Code List” (pg. 75).
- 6 Press **SET UP** to complete the setting.

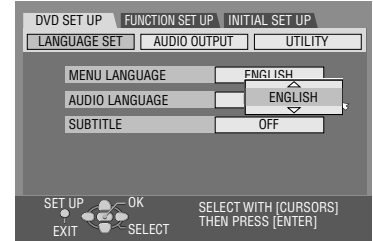

NOTE:

When the selected language is not available on the disc, the disc's default menu language is played back.

Monitor Set

You can select the monitor type depending on the TV used when you play back DVD VIDEO discs recorded for wide-screen TVs.

- Turn on the unit.
- Turn on the TV and select an input mode such as EXT1.

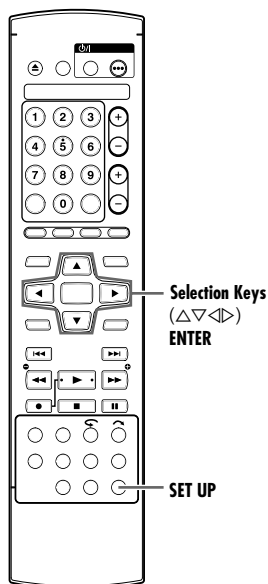

1 Press **SET UP** to access the Main Menu screen.

2 Press **selection keys** to select "FUNCTION SET UP", then press **ENTER**.

3 Press **selection keys** to select "VIDEO IN/OUT", then press **ENTER**.

4 Press **selection keys** to select "MONITOR TYPE", then press **ENTER**.

5 Press **selection keys** to select the desired setting, then press **ENTER**.

6 Press **SET UP** to complete the setting.

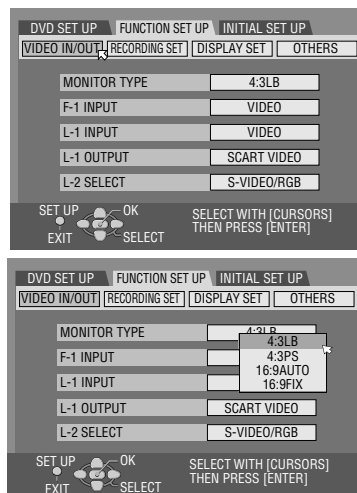

* The **boldface** settings below indicate the settings at your purchase.

■ MONITOR TYPE — **4:3LB** / 4:3PS / 16:9AUTO / 16:9FIX

4:3LB (Letter Box conversion):

Select this when the aspect ratio of your TV is 4:3 (conventional TV). While viewing a wide screen picture, the black bars appear on the top and the bottom of the screen.

4:3PS (Pan&Scan):

Select this when the aspect ratio of your TV is 4:3 (conventional TV). While viewing a wide screen picture, the black bars do not appear; however, the left and right edges of the pictures will not be shown on the screen.

16:9AUTO (Wide television conversion):

Select this when the aspect ratio of your TV is 16:9 (wide TV).

16:9FIX (Wide television conversion):

Select this when the aspect ratio of your TV is fixed to 16:9 (wide TV). The unit automatically adjusts the screen width of the output signal correctly when playing back a picture whose aspect ratio is 4:3.

Pan&Scan/Letter Box

In general, DVD VIDEO disc are produced for a wide-screen TV with 16:9 aspect ratio.

Material with this ratio will not fit to a TV with 4:3 aspect ratio.

There are two styles to display the image, "Pan&Scan" (PS) and "Letter Box" (LB).

Pan&Scan

The right and left side of the image are cut off. The image fills the screen.

- The picture will be shown in the "4:3LB" mode depending on the disc even if the "4:3PS" mode is selected.



Letter Box

Black bands appear at the top and bottom of the image. The image itself appears in 16:9 aspect ratio.



Basic Playback



- Turn on the unit.
- Turn on the TV and select an input mode such as EXT1.

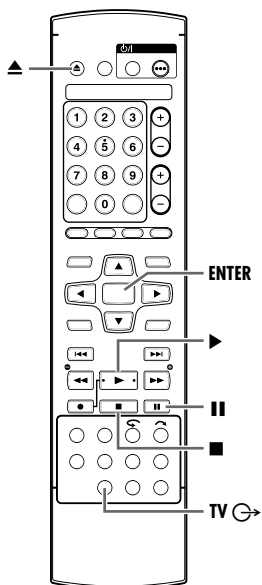
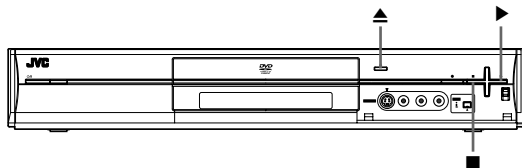

- ATTENTION:**
- It takes approximately 30 seconds to read a disc depending on the type and condition of the disc since this unit is multi-disc compatible (DVD-RAM, DVD-RW, DVD-R). It may even take several minutes when a disc is dirty, scratched or warped.
 - It may take a few seconds to start playback. This is not a malfunction.
 - Forward/reverse high-speed search and other operations cannot be performed while playback is stopped.

To play back an MP3/JPEG disc, see “Playback With MP3/JPEG Navigation” (pg. 53).

- 1 Load a disc.
 - For details, refer to “Placing A Disc” (pg. 9).
 - Pressing ▲ also closes the disc tray.
 - Playback begins automatically if an auto-playback DVD disc is loaded.
- 2 Press ► to start playback.
 - If you load a DVD disc whose region code does not match the unit, “REGION CODE ERROR CHECK DISC” appears on the TV screen. For details, refer to “Region Number” (pg. 7).
 - With Video CD/SVCD discs with PBC control or some DVD discs, the menu display may appear on the TV screen after starting playback. In this case, select an item which you want to play back from the menu. For details, refer to “Playback Control (PBC) Function” (pg. 27) or “Locating A Desired Scene Using The DVD Menu” (pg. 24).
 - The Library Database Navigation also enables you to search and scan the beginning of the desired titles. (pg. 45)
- 3 Press II to pause playback.
 - To resume normal playback, press ►.
- 4 Press ■ to stop playback.
 - When a recordable disc is played, playback stops and a programme received with the unit’s tuner resumes on the TV screen.
 - When a playback-only disc is played, playback stops and the TV screen becomes all blue when you press ■. Pressing ■ again resumes a programme received with the unit’s tuner.
 - If ▲ is pressed during playback, playback stops, then the disc tray opens.

NOTE:
When the Library Database Navigation screen appears, choose a thumbnail image of the desired title on the TV screen, then press **ENTER**. (pg. 45)

Each time you press **TV** (TV with a circle arrow), the unit switches between video mode (or connected external mode) and TV mode. (pg. 14)
“TV” lights on the front display panel when video mode is selected. (pg. 13)

Playback Features

- Turn on the unit.
- Turn on the TV and select an input mode such as EXT1.

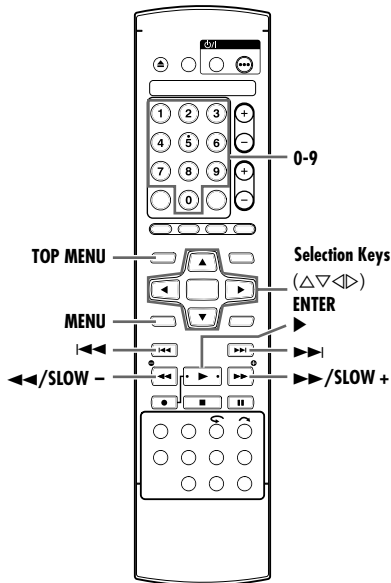

Locating A Desired Scene Using The DVD Menu



DVD VIDEO discs may have top menu and disc menu.

Top menu

DVD discs generally have their own menus which show the disc contents. These menus contain various items such as titles of a movie, names of songs, or artist information. You can locate a desired scene by using the top menu displayed on the TV screen. Press **TOP MENU** to access the top menu.

Disc menu

Disc menus include playback data (angle menu, subtitle menu, etc.) specific to each title. Press **MENU** to access the disc menu.

1 Press **TOP MENU** or **MENU** to access the DVD menu.

2 Press **selection keys** to select the desired title, then press **ENTER**. The playback starts.

- It may be possible to select the desired item using the **number keys** depending on the menu display.

Example:

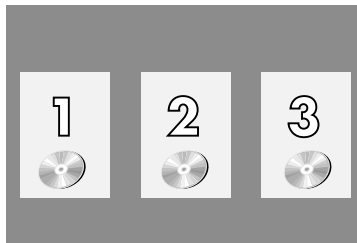

NOTE:

When "⊖" appears on the TV screen in step 1, the disc does not have a top menu or disc menu.

Locating The Start Point Of The Item Or Skip The Item



Press **⏪** or **⏩** during playback.

- Pressing **⏩** locates the start point of the title (or track) or skips to the marked point in the forward direction, then resumes playback.
- Pressing **⏪** locates the start point of the title (or track) or skips to the marked point in the reverse direction, then resumes playback.

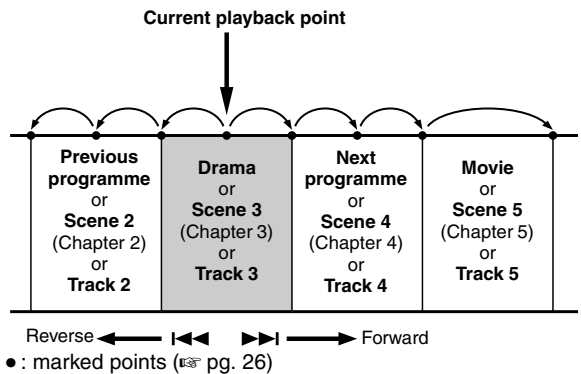

Variable Speed Search



During playback, press **⏩** for forward variable speed search, or **⏪** for reverse variable speed search.

- Each press of the button increases the search speed for each direction.
- To resume normal playback, press **▶**.

OR

During playback, press and hold **⏩** for 2 or more seconds for forward variable speed search, or press and hold **⏪** for 2 or more seconds for reverse variable speed search.

- Releasing the button resumes normal playback.

Still Picture/Frame-By-Frame Playback



1 Press **⏸** to pause during playback.

2 Each press of **⏸** advances a frame.

- Each press of **⏸** advances the still picture frame by frame.

OR

Press **◀** or **▶** to activate frame-by-frame playback.

- Each press of **◀** or **▶** reverses/advances the still picture frame by frame.
- Frame-by-frame playback for reverse direction cannot be performed with Video CD/SVCD discs.
- To resume normal playback, press **▶**.

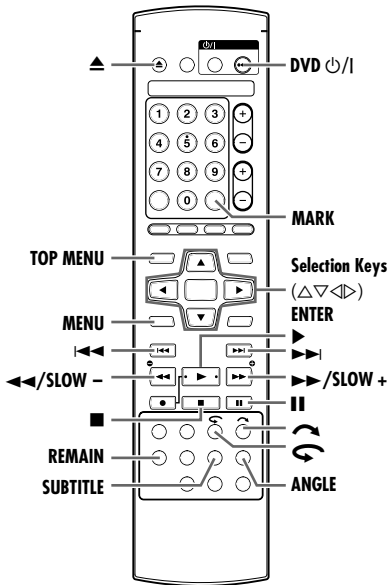

Slow Motion



- 1 Press **II** to pause during playback.
- 2 Press **SLOW -** (◀◀) or **SLOW +** (▶▶).
 - Each press of **SLOW -** (◀◀) or **SLOW +** (▶▶) increases the slow motion speed for each direction.
 - Slow motion for reverse direction cannot be performed with Video CD/SVCD discs.

OR

- Press and hold **◀◀** or **▶▶** for 2 or more seconds.
- Releasing the button resumes normal playback.

Skip Search



- Press **↶** during playback.
- Each press initiates an approximately 30 second period of fast-motion playback. Normal playback resumes automatically.
 - This function is not possible when playing back a Video CD using the PBC function.

One Touch Replay



- You can move back the playback position slightly.
- Press **↶**.
- Each press skips back for approximately 7 seconds and resumes playback.
 - Pressing while paused skips back for approximately 7 seconds and resumes pause.
 - This function is not possible when playing back a Video CD using the PBC function.

Resume Function



It is possible to memorise the position where you stop playback and resume playback from that position.

- Be sure to set "RESUME" to "ON" or "DISC RESUME". (☞ pg. 63)

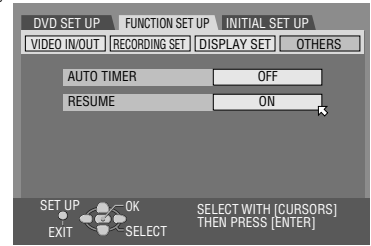

ATTENTION:
When a playback-only disc is played, pressing **■** once results in a blue screen. To perform Resume Function with these discs, follow the procedures as described below under the blue screen condition.

- 1 Press **■** during playback to memorise a resume point.
 - The unit enters Resume Stop mode and memorises the position where you have stopped playback as a resume point. (The inside of the disc status indicator on the front display panel blinks while memorising.)
 - The unit retains a memory of the resume points of the last 30 discs played back, even though they have been ejected if "RESUME" is set to "DISC RESUME". (☞ pg. 63)
 - To clear the resume points: (The inside of the disc status indicator stops blinking and lights.)

When "RESUME" is set to "ON":

- Press **DVD On/Off** to turn off the unit.
- Press **▲** to take out the disc.
- Press **■** in stop mode.
- Press **TOP MENU** to display the top menu, then start playback by selecting an item, etc.
- Press **MENU** to display the disc menu, then start playback by selecting an item, etc.

When "RESUME" is set to "DISC RESUME":

- "RESUME" must be set to "OFF". (☞ pg. 63)
- Press **■** in stop mode.
- Press **TOP MENU** to display the top menu, then start playback by selecting an item, etc.
- Press **MENU** to display the disc menu, then start playback by selecting an item, etc.

- 2 Press **▶** in stop mode to resume playback. The unit starts playback from the resume point.

NOTES:

- "DISC RESUME" setting works on DVD VIDEO, VCD, SVCD and finalised DVD-R/DVD-RW (Video mode) discs. For other types of discs, the function under "ON" setting will be applied even if "RESUME" is set to "DISC RESUME". (☞ pg. 63)
- If you stop the playback of a disc for which a resume point has already been memorised, the memory will be updated with the new resume point.
- After the unit has memorised the resume points for 30 discs, remembering a new resume point will cause the unit to delete the oldest memorised point. Stopping playback of a disc for which a resume point is already stored may change the order in which the points are stored. This may potentially change the order in which points are deleted.
- When the unit memorises a resume point for a disc, it also remembers audio language, subtitle and angle settings.
- This function may not work for some Video CD/SVCDs.
- When "RESUME" is changed to "ON" or "OFF" (☞ pg. 63), resume points of the discs memorised with "RESUME" set to "DISC RESUME" will be cleared.
- Resume points are memorised for each side of a double-sided disc.

Marking Positions To Play Back Again Later



It is possible to mark positions (up to 999 points) where you want to play back once again later, and start playback from a marked position.

To mark positions:

During playback, press **MARK** at positions you want to mark.

- “MARK” is displayed on the TV screen. You can easily locate the marked positions using **◀◀** or **▶▶** when you play back the disc.

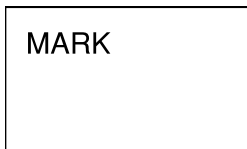

To delete the marked positions:

While paused, press **◀◀** or **▶▶** to locate a marked position you want to delete, then press **MARK**.

- Crossed “MARK” appears on the TV screen, and the marked position is deleted.



NOTES:

- When a DVD-R/RW (Video mode) disc is finalised, marked points that are marked at the desired locations during playback are deleted and new marks are assigned automatically approximately every 5 minutes.
- If **MARK** is pressed when playing back a disc that does not allow marks to be inserted, “⊘” appears on the TV screen.

Checking The Time Information



You can check time information of a disc on the front display panel and the TV screen.

Each press of **DISPLAY** changes the display as follows:

■ DVD-RAM/DVD-R/DVD-RW

During recording or playback

Clock time → Current title elapsed time → Disc remaining time → (back to the beginning)

- The clock time is displayed on the front display panel only.
- The clock time and disc remaining time will not be displayed when playing back finalised DVD-R/RW discs.

During recording/playback or in stop mode

- It is possible to check disc remaining time according to recording modes also by pressing **REMAIN**.
- In FR mode, it is possible to set recording time in detail. While the recording mode and the disc remaining time are displayed by pressing **REMAIN**, press **selection keys** to select “FR”, then select the desired recording time. (pg. 37)
- It is not possible to switch the recording mode during playback or while recording.

■ Video CD/SVCD/Audio CD

During playback or in stop mode

Current track elapsed time → Current track remaining time → Total elapsed time → Total remaining time → (back to the beginning)

NOTE:

When a PBC-compatible Video CD/SVCD disc is loaded, deactivate the PBC function. (pg. 27)

Angle Selection



You can enjoy a variety of scene angles if a DVD VIDEO disc contains “multi-angle” parts, where the same scene was shot from different angles.

If the disc contains “multi-angle” parts, “” appears on the TV screen at the beginning of the “multi-angle” part.

1 Press **ANGLE** during playback.

The angle selection display appears on the TV screen.



When 3 scene angles are contained.

2 Press **ANGLE** or the **selection keys** to select your desired angle.

- Each time you press **ANGLE** or the **selection keys**, the angle changes.
- When “” appears on the TV screen, the current scene is not recorded from multiple angles. In addition, some discs prohibit angle selection.
- To clear the angle selection display, press **ENTER**. In addition, the angle selection display disappears automatically if no operation is done for 5 seconds.

Subtitle Selection



Some DVD VIDEO discs contain more than one subtitle language, from among which you can choose the desired subtitle language. “” appears on the TV screen at the beginning of the part where more than one subtitle language are recorded.

1 Press **SUBTITLE** during

playback. The subtitle selection display appears on the TV screen.



When 3 subtitle languages are contained.

- Each time you press **SUBTITLE**, the subtitle display is switched on and off.

2 Press **selection keys** to select your desired language.

- To clear the subtitle selection display, press **ENTER**.

NOTES:

- For disc that does not contain subtitle language, the number of selectable languages will not be displayed. “-/-” appears on the TV screen.
- When the subtitle language won't be changed with the procedure above, change the subtitle on a disc menu displayed by pressing **MENU**.

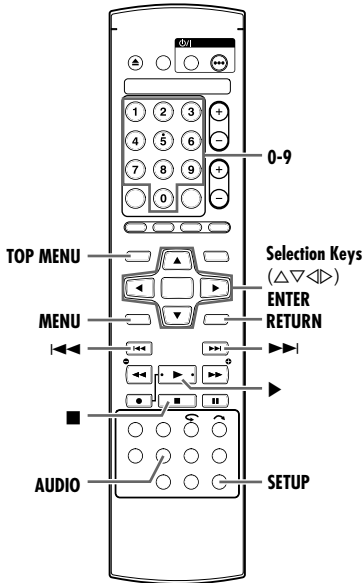

Audio Channel Selection



When watching bilingual programmes or playing discs on which you recorded bilingual or stereo programmes, you can choose the desired audio channel.

- When “SUPERIMPOSE” is set to “AUTO”, you can confirm on the TV screen the audio channel you have chosen. (pg. 62)
- Each time you press **AUDIO**, the audio channel changes.



TRACK	USE
On-Screen Display	
	For main audio of bilingual programme
	For sub audio of bilingual programme
	For stereo discs
	For audio of left channel
	For audio of right channel

When you can't switch the audio channel of a bilingual programme

When the unit is connected with a digital audio device using an optional coaxial cable and “DIGITAL AUDIO OUT” is set to “DOLBY DIGITAL/PCM”, it is not possible to switch the audio channel of a bilingual programme recorded on a DVD-RAM or DVD-RW (VR mode) disc. (pg. 61). In this case, perform the following steps using the remote control to switch “DIGITAL AUDIO OUT” from “DOLBY DIGITAL/PCM” to “PCM ONLY”.

- 1 Press **SET UP** to access the Main Menu screen.
- 2 Press **selection keys** to select “DVD SET UP”, then press **ENTER**.
- 3 Press **selection keys** to select “AUDIO OUTPUT”, then press **ENTER**.
- 4 Press **selection keys** to select “DIGITAL AUDIO OUT”, then press **ENTER**.
- 5 Press **selection keys** to select “PCM ONLY”, then press **ENTER**.
- 6 Press **SET UP** to complete the setting.
- 7 Press **AUDIO** during playback to select the desired audio channel.

Audio Language/Sound Selection



Some DVD VIDEO discs contain the multiple audio language or sound. You can select the desired audio language or sound. For some Video CD/SVCD discs, you can switch the audio channel to choose Karaoke either with or without the vocal.

- 1 Press **AUDIO** during playback.

The Audio Language/Sound selection display appears on the TV screen.

Example: DVD VIDEO

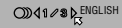

- 2 Press **AUDIO** or the **selection keys** to select your desired audio language/sound.

When 3 audio languages are contained.

- Each time you press **AUDIO** or the **selection keys**, the audio language/sound changes.
- To clear the Audio Language/Sound selection display, press **ENTER**.

NOTES:

- When “” appears on the TV screen, no audio language is recorded.
- When the audio language won't be changed with the procedure above, change the audio on a disc menu displayed by pressing **MENU**.
- Pressing **AUDIO** to select the audio language/sound is only possible during playback. It is not possible to select by pressing **AUDIO** in stop mode. However, you can select the desired audio language/sound from the setup menu while in stop mode.

Playback Control (PBC) Function



Some Video CD/SVCD discs support the PBC function. PBC is an abbreviation of “Play Back Control”. A Video CD/SVCD disc recorded with PBC has its own menus, such as a list of the songs on the disc. You can locate a specific scene by using the menu.

- 1 Press **▶** in stop mode. The PBC menu appears.

- 2 Press the **number keys** to enter the number of the desired scene, then press **ENTER**. The unit starts playback of the selected item.

- “PBC” is displayed on the front display panel.
- When “NEXT” or “PREVIOUS” appears on the TV screen: Pressing **▶▶** advances to the next page. Pressing **◀◀** returns to the previous page.
- You can return to the menu by pressing **RETURN**.
- The method of the operation is different depending on the disc.

NOTES:

- If you want to play back a PBC-compatible Video CD/SVCD disc without activating the PBC function, start playback in stop mode by using the **number keys**, instead of the **▶** button, to choose the track, then press **ENTER**.
- To activate the PBC function when a PBC-compatible Video CD/SVCD disc is being played back without the PBC function, press **■** and clear the resume points (pg. 25), then press **▶**.

Live Memory Playback



You can watch a recorded portion of a programme even before recording ends (Live Memory Playback), or watch other programmes (Simultaneous Recording and Playback) while continuing to record onto the DVD-RAM disc.

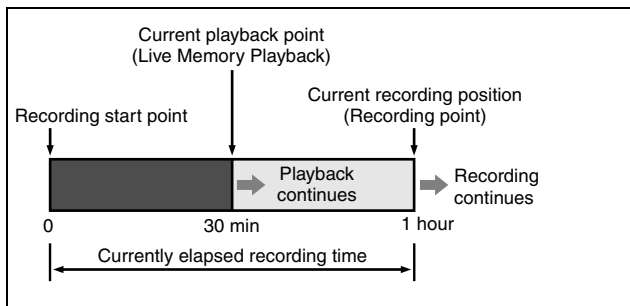
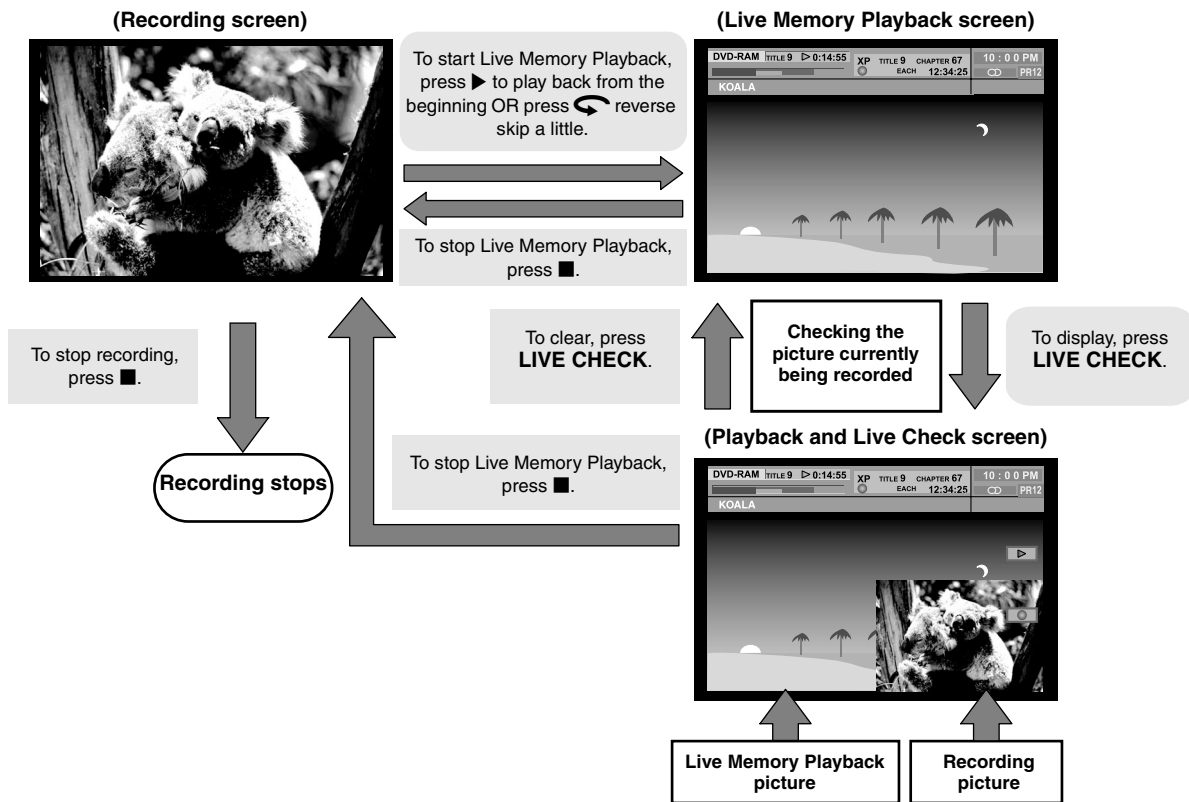

NOTES:

- Live Memory Playback could be performed approximately 30 seconds after recording has started.
- Although high-speed search up to approximately 30 seconds before the current recording point is possible during Live Memory Playback, once the current recording point is reached, the unit resumes normal playback and maintains a delay of approximately 30 seconds so that recording and playback can continue.
- When using Live Memory Playback during timer recording, the unit remains turned on and playback continues even after the end of the recording.
- When using Live Memory Playback during timer recording, playback is automatically stopped just before recording starts, and then recording starts when the time arrives for the next timer programme.
- It is impossible to perform ITR even if you press **●** during Live Memory Playback. Press **■** to display the programme being recorded, then perform ITR settings.
- Playback may be paused for a moment during Live Memory Playback, which does not interfere with recording.
- When **LIVE CHECK** is pressed to display the picture currently being recorded, the picture size may not be correct.
- Live Memory Playback cannot be performed while recording the source from DV input. (pg. 54)

- Turn on the unit.
- Turn on the TV and select an input mode such as EXT1.

Live Memory Playback

You can play back the previous part of the channel you are recording.

To watch from the recording start point

- 1 Press **▶** during recording.

To watch from the point after reverse skipping a little during recording

- 1 Press **↶** during recording.
 - Live Memory Playback could be performed approximately 30 seconds after recording has started.
 - Pressing once skips back for approximately 7 seconds and resumes playback.

Simultaneous Recording and Playback

You can playback other programmes available in the Library Database Navigation on the disc.

To watch other previously recorded programmes during recording

- 1 Press **NAVIGATION** to display the Library Database Navigation screen.
- 2 Press **selection keys** to select "ORIGINAL", then press **ENTER** for confirmation.
- 3 Press **selection keys** to select a desired programme, then press **ENTER**.

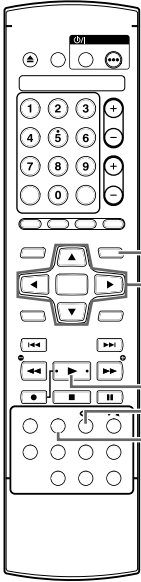

NAVIGATION
Selection Keys
(Δ▽◀▶)
ENTER

ON SCREEN

Live Memory Playback status can be checked by pressing **ON SCREEN** to display the bar meter on the superimpose display. The current status is superimposed on the TV screen.

Bar meter display

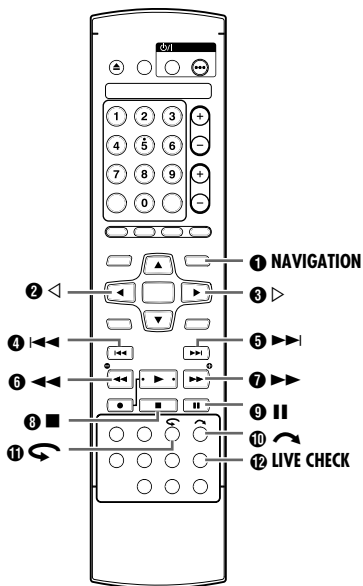

Buttons To Be Used During Live Memory Playback

**1 NAVIGATION**

Displays Library Database Navigation menu. You can choose a title to play back.

2 ◀

Pressing during pause mode reverses the still picture frame by frame.

3 ▶

Pressing during pause mode advances the still picture frame by frame.

4 ◀◀

- Pressing once skips back to the beginning of the programme or chapter being played back.
- Pressing down for 2 or more seconds during playback reverses playback at a faster speed. Releasing the button resumes normal playback.

Available only when paused

- Pressing down for 2 or more seconds reverses playback at a slower speed.

5 ▶▶

- Pressing once skips forward to the next programme or chapter being played back.
- Pressing down for 2 or more seconds during playback advances playback at a faster speed. Releasing the button resumes normal playback.

Available only when paused

- Pressing down for 2 or more seconds advances playback at a slower speed.

6 ◀◀◀

- Each press of the button during playback advances the playback speed in 5 steps in the reverse direction.
- Pressing during pause mode reverses playback at a slower speed.

7 ▶▶▶

- Each press of the button during playback advances the playback speed in 4 steps in the forward direction.
- Pressing during pause mode advances playback at a slower speed.

8 ■

- Pressing once stops Live Memory Playback and returns to the screen on air.
- Pressing again stops the recording and returns to the screen on air.

9 ||

- Pressing once pauses playback (still picture playback).
- Pressing repeatedly advances the still picture frame by frame.

10 ▶↻

It is useful when skipping over unwanted sections.

- Pressing once skips forward for approximately 30 seconds and resumes playback.
- Pressing repeatedly skips forward continuously as many times as pressed.

11 ◀↻

It is useful when watching sports programmes, etc.

- Pressing once skips back for approximately 7 seconds and resumes playback.
- Pressing repeatedly skips back continuously as many times as pressed.

12 LIVE CHECK

You can check, for example, if the programme you are recording has already finished.

- Pressing once displays the picture currently being recorded and the one being played back simultaneously.
- Pressing successively clears the Live Check window and displays only the picture currently being played back.

Using The On-screen Bar



The on-screen bar allows you to control various playback functions. Some of the functions operated on Navigation Menu can be controlled on the On-screen bar.

Be sure to clear Library Database Navigation screen by pressing **NAVIGATION**.

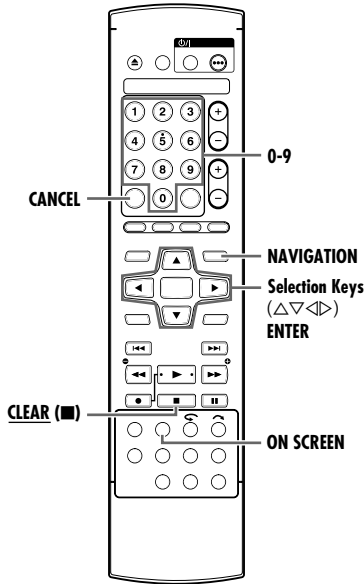

How To Access The On-screen Bar

- 1 Press **ON SCREEN** twice whenever a disc is loaded.

Contents of the on-screen bar during playback

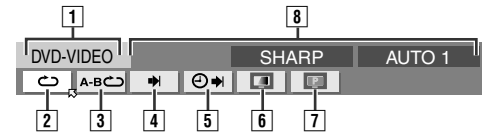

Video CD/Super Video CD

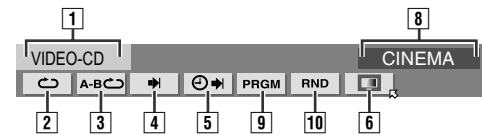

JPEG disc



- 1 Disc type.
- 2 Select this for Repeat Playback. (pg. 31)
- 3 Select this for A-B Repeat Playback. (pg. 32)
- 4 Select this for search function. (pg. 32)
- 5 Select this for time search function. (pg. 33)
- 6 Select this for Picture Control function. (pg. 33)
- 7 Select this to switch picture source type. (pg. 33)
- 8 Current status area for the selected item.
- 9 Select this for Programme Playback. (pg. 34)
- 10 Select this for Random Playback. (pg. 34)
- 11 Select this to control the switching interval of the slide show. (pg. 34)

NOTE:

Although examples of the on-screen bar are provided here only for 3 types of discs, the on-screen bar will be displayed for whichever disc indicated in the left column.

Basic Operation On The On-screen Bar

Example: When selecting Picture Control function of DVD

During playback or while stopped

- 1 Press **ON SCREEN** twice to access the on-screen bar. The item currently selected is highlighted and pointed by



- 2 Press **selection keys** to select "SHARP", then press **ENTER**. The pop-up window appears under the selected item.



- 3 Press **selection keys** to select the desired option, then press **ENTER**.

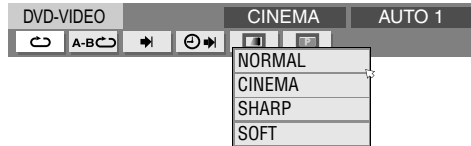

To clear the on-screen bar

Press **ON SCREEN**.

NOTE:

See the corresponding pages for details on each menu item.

Repeat Playback



You can repeat playback as you like according to the type of disc.

- 1 Press **ON SCREEN** twice to access the on-screen bar.
- 2 Press **selection keys** to select "A-B", then press **ENTER**. The pop-up window appears under the selected item.



- 3 Press **selection keys** repeatedly to select the desired Repeat mode, then press **ENTER**.

DVD-RAM/RW/R

OFF:

Repeat playback is not performed.

ALL REPEAT:

The whole disc is played back repeatedly.

TITLE REPEAT:

The current title is played back repeatedly.

DVD VIDEO

OFF:

Repeat playback is not performed.

TITLE REPEAT:

The current title is played back repeatedly.

CHAPTER REPEAT:

The current chapter is played back repeatedly.

Audio CD/Video CD/SVCD/JPEG/MP3

OFF:

Repeat playback is not performed.

ALL REPEAT:

The whole disc is played back repeatedly.

TRACK REPEAT*:

The current track is played back repeatedly.

* "TRACK REPEAT" cannot be selected for JPEG discs.

To clear the on-screen barPress **ON SCREEN**.**To cancel Repeat Playback**Repeat the above procedure from step 1, select "OFF" in step 3, then press **ENTER**.**NOTES:**

- Repeat Playback is not possible for a Video CD/SVCD with PBC function.
- Repeat Playback may not work properly depending on the type of the disc being used.

A-B Repeat Playback

You can repeat the desired part.



During Playback

- 1 Press **ON SCREEN** twice to access the on-screen bar.
- 2 Press **selection keys** to select "A-B .
- 3 Press **ENTER** at the beginning of the desired part you want to repeat (point A). The elapsed playing time of the point A appears.



- 4 Press **ENTER** at the end of the desired part you want to repeat (point B). The elapsed playing time of the point B appears.
 - The selected part of the disc (between point A and B) is played repeatedly.

**To clear the on-screen bar**Press **ON SCREEN**.**To cancel A-B Repeat Playback**Press **selection keys** to select "A-B , then press **ENTER**.**NOTES:**

- A-B Repeat Playback may not work properly depending on the type of disc being used.
- The subtitles recorded around the A-B point may not appear.
- When the end of the item is reached before the end point is set, the on-screen bar disappears from the TV screen. In such a case, repeat the procedure from step 1.
- The point B must be set at least 3 seconds after the point A.
- When playing back a DVD, A-B Repeat Playback is possible only within the same title.
- "A-B " cannot be selected during Programme and Random Playback.
- "A-B " cannot be selected while stopped.

Locating The Beginning Of A Desired Selection

You can locate the beginning of a title, chapter, group or track.

During playback or while stopped

- 1 Press **ON SCREEN** twice to access the on-screen bar.
- 2 Press **selection keys** to select "**▶**", then press **ENTER**.

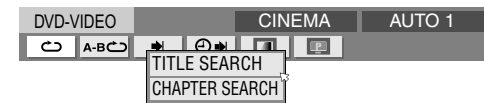

- 3 Press **selection keys** to select the desired option, then press **ENTER**.
 - Skip this step for Video CD/SVCD and Audio CD.

NOTE:

Settings that are selectable during playback and stop mode differ depending on the type of disc and search used.

- 4 Press the **number keys** to enter the desired title or chapter number, then press **ENTER**.
 - Playback starts from the selected section.



Example:

- 1 To select track 5, press the **number key "5"**.
- 2 To select track 15, press the **number keys "1" and "5"**.
- 3 To select track 25, press the **number keys "2" and "5"**.

If you have specified a wrong numberPress **CLEAR** (■) or **CANCEL** on the remote control and re-enter again.**To clear the on-screen bar**Press **ON SCREEN**.**NOTES:**

- When " is displayed on the TV screen in step 4, the chapter you have selected is not contained in the disc, or chapter search does not work on the disc.
- Before you press **ENTER**, playback may start automatically when you enter the section's number depending on the disc.
- This function is not possible for a Video CD/SVCD with PBC function.

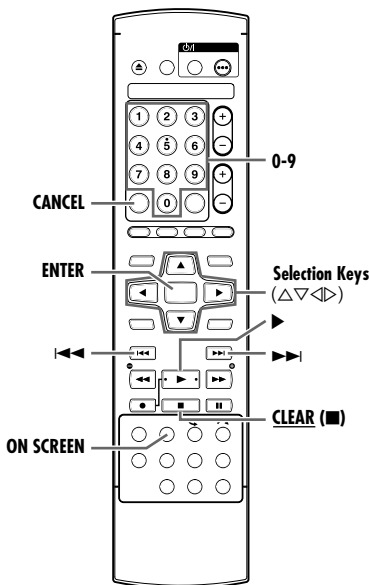

Time Search



You can play back a disc from the desired point by specifying the elapsed playing time from the beginning of a programme (DVD-RAM, DVD-R, DVD-RW and DVD VIDEO) or a disc (Video CD/SVCD and Audio CD).

- 1 Press **ON SCREEN** twice to access the on-screen bar.
- 2 Press **selection keys** to select “⏪▶”, then press **ENTER**. The pop-up window appears under the selected item.



- 3 Press the **number keys** to enter the desired title or chapter number, then press **ENTER**. Playback starts from the specified time.

Example:
To play back from a point 12 (minutes): 50 (seconds) elapsed.

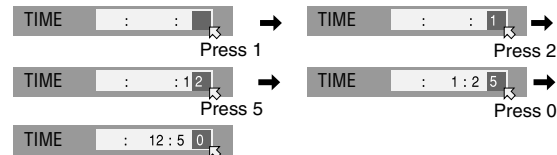

If you have specified a wrong number

Press **CLEAR (■)** or **CANCEL** on the remote control and re-enter again.

To clear the on-screen bar

Press **ON SCREEN**.

NOTES:

- When “⏪▶” is displayed on the TV screen in step 3, you have selected a point that exceeds the recording time of the disc.
- Some DVD VIDEO discs do not contain time information, and it is not possible to use the Time Search function. In such cases, “⏪▶” is displayed on the TV screen as well.
- This function is not possible for a Video CD/SVCD with PBC function.

Adjusting The Picture Quality



You can obtain optimal picture quality by selecting an appropriate picture mode.

- 1 Press **ON SCREEN** twice to access the on-screen bar.
- 2 Press **selection keys** to select “🖥️”, then press **ENTER**. The pop-up window appears under the selected item.

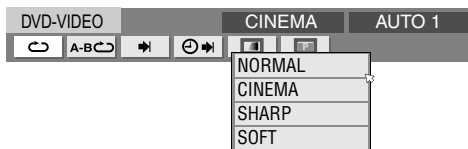

- 3 Press **selection keys** to select the desired option, then press **ENTER**.

NORMAL:

Normally select this.

CINEMA:

Suitable for a movie disc, etc.

SHARP:

Clearer, sharper-edged picture when viewing images with lots of flat, same-coloured surfaces such as cartoons.

SOFT:

Select this option when too much noise appears.

To clear the on-screen bar

Press **ON SCREEN**.

Setting The Progressive Mode



You can obtain optimal picture quality by selecting whether the content on the disc is processed by field (video source) or by frame (film source).

- 1 Set the unit to the progressive scan mode. (pg. 64)
- 2 Press **ON SCREEN** twice to access the on-screen bar.
- 3 Press **selection keys** to select “🖥️”, then press **ENTER**. The pop-up window appears under the selected item.

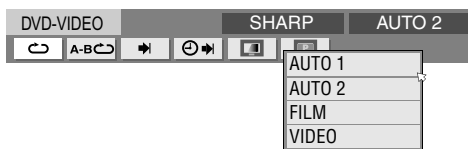

- 4 Press **selection keys** to select the desired option, then press **ENTER**.

AUTO 1:

This mode automatically detects film and video content for progressive playback. When film content is found, flag detection is used to invoke playback of film data in full screen. When video content is found, pictures from multiple fields are used to detect sections with movement, and then this movement undergoes advanced image processing for output of sharp, detailed progressive images without any reduction in image quality where movement occurs. Normally, operation in this mode is recommended.

AUTO 2:

Only the processing of sections with movement differs from “AUTO 1”.

For video contents, the sections with movement are detected and the pictures are corrected by the filtering process for motion pictures.

FILM:

Suitable for playing back a progressive scanned film source disc.

VIDEO:
Suitable for playing back a video source disc. The outlines on the played back pictures will be soft.

To clear the on-screen bar
Press **ON SCREEN**.

Programme Playback



You can programme up to 30 tracks (Video CD/SVCD or Audio CD) to play back in the desired order.

While stopped

- 1 Press **ON SCREEN** twice to access the on-screen bar.
- 2 Press **selection keys** to select "PRGM", then press **ENTER**. The programme table appears under on-screen bar.
- 3 Press the **number keys** to enter the track numbers in the desired order.

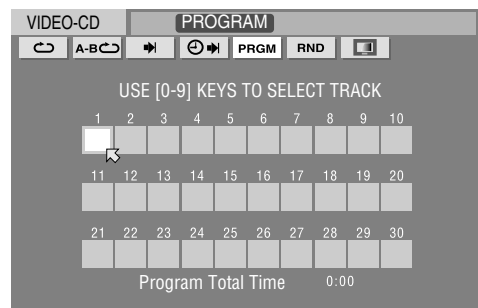

Example:

- 1 To select track 5, press the **number key "5"** and **ENTER**.
- 2 To select track 15, press the **number keys "1"** and **"5"**.
- 3 To select track 25, press the **number keys "2"** and **"5"**.

If you have specified a wrong selection

Press **CANCEL**. The last selection is erased.

Or press **CLEAR** (■). The whole selection is erased.

- 4 Press **▶**. Playback starts in the programmed order.
 - When all of the programmed tracks have been played back, Programme Playback stops, but the programmed information remains.
 - To add tracks to the end of the programme, perform steps 1 to 3.
 - During Programme Playback, pressing **▶▶** skips to the next track of the programme. Pressing **◀◀** returns to the beginning of the current track.

To clear the on-screen bar and the contents of the programme,

Press **ON SCREEN**.

To cancel Programme Playback

Press **selection keys** to select "PRGM", then press **ENTER**.

NOTE:

Programme Playback is not possible depending on the type of disc.

Random Playback



You can play back all the tracks on the disc in random order.

While stopped

- 1 Press **ON SCREEN** twice to access the on-screen bar.
- 2 Press **selection keys** to select "RND", then press **ENTER**. Playback starts in random order.



To clear the on-screen bar

Press **ON SCREEN**.

To cancel Random Playback

Perform steps 1 and 2.

NOTE:

The same track will not be played back more than once during Random Playback.

Select The Switching Interval Of The Slide Show



You can control the switching interval of the slide show.

- 1 Press **ON SCREEN** twice to access the on-screen bar.
- 2 Press **selection keys** to select "Slide Show" icon, then press **ENTER**. The pop-up window appears under the selected item.

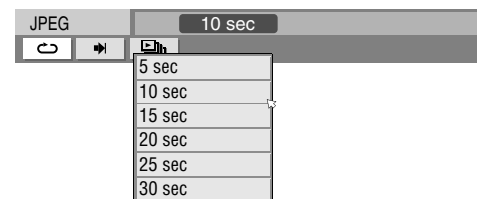

- 3 Press **selection keys** to select the desired option, then press **ENTER**.

To clear the on-screen bar

Press **ON SCREEN**.

NOTE:

JPEG files are played back as a slide show. It may take more time to display an image with larger file size.

Basic Recording



- Turn on the unit.
- Turn on the TV and select an input mode such as EXT1.

ATTENTION:
It is not possible to record programmes on a DVD-R/RW disc which has already been finalised.

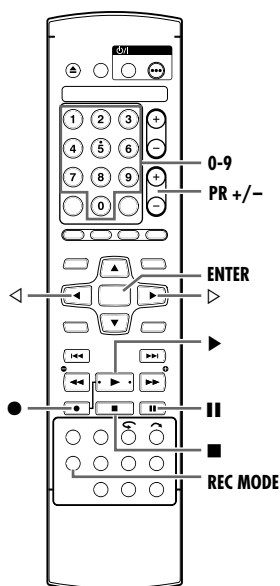
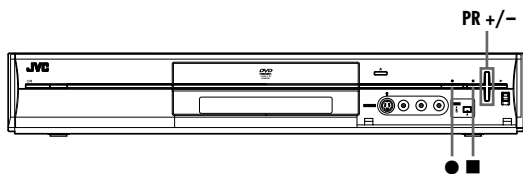

- Load a recordable disc.
 - For details, refer to "Placing A Disc" (pg. 9).
- Press **PR +/-** or the **number keys** to select the channel you wish to record.
- Press **REC MODE** repeatedly to select the recording mode, then press **ENTER**.
 - Each time you press **REC MODE**, the recording mode changes as follows:
XP → SP → LP → EP → FR (60-360*, 420, 480) → (Back to the beginning)
 - * The value is selectable from 1 to 6 hours in 5 minutes interval by pressing <D> repeatedly after selecting "FR60-FR360". To change the value in 30 minutes interval, press and hold <D>.
 - For details on the recording mode, see the right column.
- Press ● on the unit to start recording. Or while holding ●, press ► on the remote control.
- Press || to pause recording.
 - To resume recording, press ►.
- Press ■ to stop recording.
 - It takes about 10 seconds to end the writing session when you stop recording.

NOTES:

- It is recommended to format a DVD-RAM disc before use if you use the disc on this unit for the first time. (pg. 70)
- When using a brand-new DVD-RW disc, format the disc either in VR mode or in Video mode. (pg. 70)
- Recordings made on DVD-R/RW disc must be finalised to play back on other DVD players. Perform "Finalise A Disc" (pg. 71).
- You can record up to 99 programmes and 99 play lists on each disc.
- Some programmes can only be recorded one time.
- When recording is started, an index of the first part of recording is automatically recorded. (pg. 44) To delete the index, refer to page 47.
- Recording sometimes may stop or cannot be performed even if there is enough available capacity remaining on the disc.

Recording Mode

MPEG 2 format is used as recording format. As a guide for picture quality, the "bps" unit is used to represent how much data can be recorded per second. The larger this value is, the better the picture quality becomes but more capacity is required for the recording. Select XP or SP for programmes where quick movement occurs, such as sports programmes, and LP or EP for talk shows, etc. with relatively less movement.

The recording modes for a 4.7 GB disc are set as follows:

Recording mode	Recording amount (approx.)	Maximum recording time (approx.)	
XP	10 Mbps	1 hour	
SP	5 Mbps	2 hours	
LP	2.5 Mbps	4 hours	
EP	1.6 Mbps	6 hours	
FR	60-360 (pg. 37)	The amount varies depending on the selected time.	
	420		1 – 6 hours
	480		7 hours
		8 hours	

- For details on FR mode, refer to "Free Rate Function" (pg. 37).

Recording Features

- Turn on the unit.
- Turn on the TV and select an input mode such as EXT1.

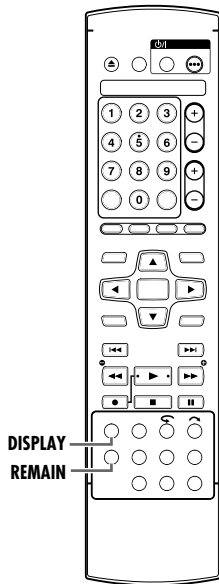
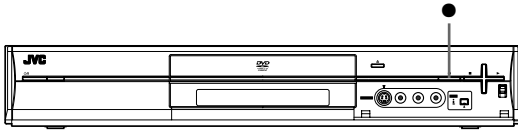

Instant Timer Recording (ITR)

It is possible to set the recording time during recording. Upon completing recording, the unit stops and shut off automatically.

- 1 Press ● on the unit to start recording.
- 2 Press ● again to engage the ITR mode.
 - “0:30” is displayed on the front display panel.
- 3 If you want to record for more than 30 minutes, press ● to extend the time. Each press extends recording time by 30 minutes.
 - Normal recording → 0:30 → 1:00 ... → Maximum disc remaining time → (back to the beginning)

NOTES:

- Perform ITR using the ● button on the unit.
- The maximum recording time changes depending on the disc remaining time.

Watch Another Programme While Recording On The Unit

While recording is going on, you can watch another programme on the TV. It does not interfere with recording.

- 1 Turn on the TV.
- 2 Select the desired channel to watch on the TV using your TV's remote control.

Elapsed Recording Time And Disc Remaining Time Indication

During recording, press **DISPLAY** repeatedly until the desired indication appears on the front display panel.

- Each time you press **DISPLAY**, the time indication changes as follows:
Elapsed recording time → Disc remaining time → Clock → (back to the beginning)
- You can also check the disc remaining time by pressing **REMAIN** while the unit is stopped or recording is in progress. The list of disc remaining times for all recording modes appears on the TV screen.

Free Rate Function

To record the entire programme, the unit automatically sets the appropriate recording mode depending on the combination of the total time of the programme to be recorded and either the remaining disc space or the specified recording time (from 60 minutes to 480 minutes when using 4.7 GB blank media disc).

■ To record the entire programme within the actual remaining disc space

Select "FR (JUST)" in a recording mode selection procedure.

- Note that this function is available only for timer programming recording (see pg. 38, 39).

■ To record the entire programme by specifying the desired recording time

Select "FR60-FR360", "FR420" or "FR480" in a recording mode selection procedure. (see pg. 35)

■ To record a 25 min. long daily programme five times just on the same DVD disc for example

Perform "VIDEO Plus+ Timer Programming" (see pg. 38) procedure. Be sure to set the recording mode to "FR125" and set Weekly/Daily Rec Function to "MON-FRI" in step 8 to fit the total recording time to the whole disc space.

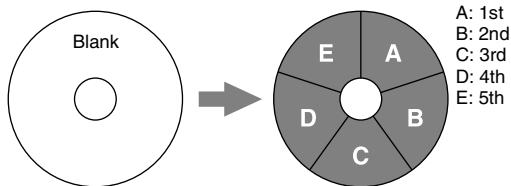

When the same programme is recorded in SP mode instead of in "FR125", the 5th programme cannot be recorded.

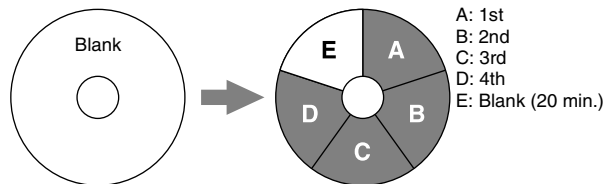

NOTES:

- You can programme this unit to timer record, regardless of the disc remaining time. When the disc remaining time is not enough, it is not possible to record until the end of the timer programme. **(Example)** If you programmed to timer-record for 60 minutes in SP mode on a 120 minutes disc, the disc remaining time would be 30 minutes in XP mode, 60 minutes in SP mode, 120 minutes in LP mode, 180 minutes in EP mode, and 240 minutes in FR480 mode. Timer recording will not complete beyond these remaining times.
- The maximum recording time of FR (JUST) mode is the same as the recording time of FR480 mode. When timer programming a long programme in FR (JUST) mode on a disc whose remaining time is short, it is recommended to check the disc remaining time in FR480 mode to see if the remaining time is enough for the programme.
- Even if more than one programme are timer programmed in FR (JUST) mode, only the first one is recorded.
- In order to ensure that the recording fits on the disc, this feature may leave a slight non-recorded section at the end of the disc.
- There may be some noise and sound disturbance at the point on the disc where the unit switches the mode.

Receiving Stereo And Bilingual Programmes

Your unit is equipped with a Digital stereo sound decoder (NICAM) making reception of stereo and bilingual broadcasts possible. When the channel is changed, the type of broadcast being received will be displayed on the TV screen for a few seconds.

Type of Broadcast Being Received	On-Screen Display
Regular Monaural	
NICAM Stereo	
NICAM Bilingual	
NICAM Monaural	

NOTES:

- "SUPERIMPOSE" must be set to "AUTO". Otherwise the on-screen displays will not appear. (see pg. 62)
- If the quality of stereo sound being received is poor, the broadcast might be received in monaural with better quality.

Selection Of The Audio Channel To Be Recorded On A Disc

When a programme is recorded on a DVD-RAM or DVD-RW disc in VR mode, all audio channels of the receiving programme are recorded on the disc. When you record a programme on a DVD-R or DVD-RW disc in video mode, select the desired audio channel ("NICAM1/MAIN", "NICAM2/SUB" or "MONO") to be recorded on the disc. (see pg. 62)

NOTE:

Before playing back a programme recorded in stereo, or a bilingual programme, refer to "Audio Channel Selection" (see pg. 27).

VIDEO Plus+ Timer Programming



You can programme this unit to timer record as many as 8 programmes.

With the VIDEO Plus+ system, timer programming is greatly simplified because each TV programme has a corresponding code number which your unit is able to recognise.

You can use the remote control to enter the PlusCode number.

- Turn on the unit.
- Turn on the TV and select an input mode such as EXT1.
- Make sure that the unit's built-in clock is set properly.

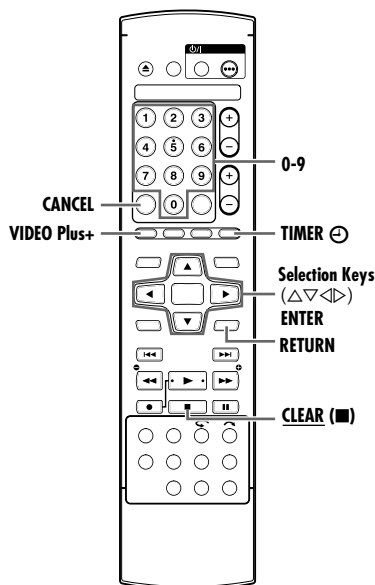

1 Load a recordable disc.

- For details, refer to "Placing A Disc" (pg. 9).

2 Press VIDEO Plus+ to display the VIDEO Plus+ screen.

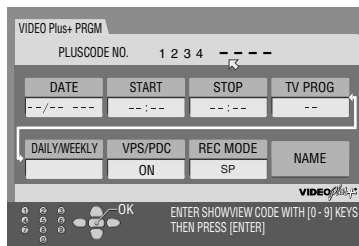

3 Press the number keys to enter the "PLUSCODE NO." of a programme you wish to record, then press ENTER.

- If you have made a mistake, press **CANCEL** and input the correct number before you press **ENTER**.
- To clear all entered numbers at a time, press **CLEAR** (M).
- If the number you entered is invalid, "PLUSCODE NO. ERROR CONFIRM PLUSCODE NO. THEN RETRY" appears on the TV screen. Input a valid "PLUSCODE NO."
- If "GUIDE PROGRAMME IS NOT SET SELECT CHANNEL YOU WANT TO RECORD" appears on the TV screen, set Guide Programme number manually.
- When "PROGRAMME FULL DELETE UNWANTED TIMER PROGRAMME" appears on the TV screen, you need to cancel some of the reserved programmes.

4 The "PLUSCODE NO." you entered and the matching timer recording information are displayed on the TV screen. Check the programme data. To cancel this setting, press RETURN.

IMPORTANT:

Make sure the channel position number you wish to record is displayed. If not, see "VIDEO Plus+ System Setup" (pg. 65) and set the Guide Programme number correctly.

5 Press selection keys to select desired recording option as required.

6 Press selection keys to select the desired setting, then press ENTER.

- "Daily/Weekly Recording Function" (pg. 38)
- "VPS/PDC Recording" (pg. 39)
- "Recording Mode" (pg. 35)
- "Modify Title Name" (pg. 47)

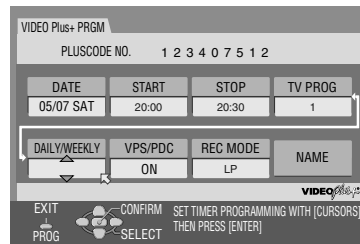

7 Press ENTER to access the Programme Confirmation screen.

8 Press ENTER to complete the timer programming.

- To programme another timer, repeat steps 2 – 8.
- If "PROGRAMME OVERLAPPED" appears on the TV screen, see "When Programmes Overlap Each Other" (pg. 42).

9 Press TIMER to engage the unit's timer mode.

- The unit turns off automatically and **TIMER** appears on the front display panel.
- To disengage the timer mode, press **TIMER** again.

IMPORTANT:

If you have moved to a different area or if a broadcasting station's channel number has been changed, the wrong channel number will be displayed on the VIDEO Plus+ programme screen in step 4. When this happens, set the correct Guide Programme number for that station.

- There may be cases that the VIDEO Plus+ Timer Programming function prolongs the stop time of the programming.
- When two successive programmes are recorded with the VIDEO Plus+ Timer Programming function, the ending of the first programme or the beginning of the second programme may not be recorded.
- If the copy limited programme is received during timer recording, the unit enters Record Pause mode. Recording starts again if it is switched to a recordable broadcast during the time you programmed.

Daily/Weekly Recording Function

You can record programmes with one of the following weekly/daily timer settings.

WEEKLY	Select to record a weekly programme.
MON-FRI	Select to record a daily programme from Monday through Friday.
MON-SAT	Select to record a daily programme from Monday through Saturday.
SUN-SAT	Select to record a daily programme from Sunday through Saturday.

Manual Timer Programming



You can programme this unit to timer record as many as 8 programmes up to 30 days in advance. If you do not know the PlusCode number for the programme you wish to record, use the following procedure to set your unit to timer record the programme.

- Turn on the unit.
- Turn on the TV and select an input mode such as EXT1.
- Make sure that the unit's built-in clock is set properly.

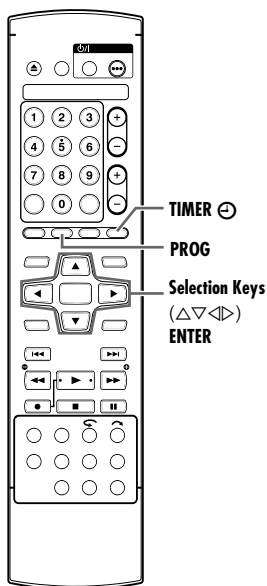

- 1 Load a recordable disc.
 - For details, refer to "Placing A Disc" (pg. 9).
- 2 Press **PROG** to display the "PROGRAMME CHECK" screen.
 - When "PROGRAMME FULL DELETE UNWANTED TIMER PROGRAMME" appears on the TV screen, you need to cancel some of the reserved programmes.
- 3 Press **selection keys** repeatedly to select "NEW TIMER PROGRAMME", then press **ENTER**.
- 4 Press **selection keys** to set the desired date ("DATE"), then press **▷**.
- 5 Press **selection keys** to set the desired start time ("START"), then press **▷**.
 - Each press of $\Delta \nabla$ increases/decreases the start time in 1 minute interval.
 - To increase/decrease the start time in 30 minutes interval, press and hold $\Delta \nabla$.

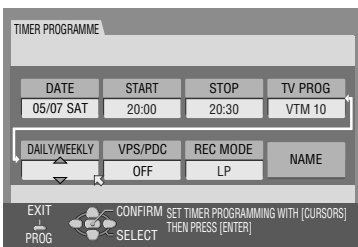
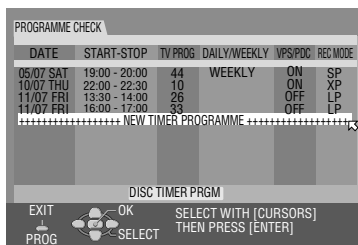

- 6 Press **selection keys** to set the desired stop time ("STOP"), then press **▷**.
 - Each press of $\Delta \nabla$ increases/decreases the stop time in 1 minute interval.
 - To increase/decrease the stop time in 30 minutes interval, press and hold $\Delta \nabla$.
- 7 Press **selection keys** to set the desired channel ("TV PROG"), then press **▷**.
- 8 Set the other recording options as required.
 - Refer to step 6 in "VIDEO Plus+ Timer Programming" (pg. 38).
- 9 Press **ENTER** to access the Programme Confirmation screen.
- 10 Press **ENTER** to complete the timer programming.
 - To programme another timer, repeat steps 2 - 10.
- 11 Press **TIMER** to engage the unit's timer mode.
 - The unit turns off automatically and \odot appears on the front display panel.
 - To disengage the timer mode, press **TIMER** again.

NOTES:

- When two successive programmes are recorded with the "Manual Timer Programming" function, the ending of the first programme or the beginning of the second programme may not be recorded.
- If the copy limited programme is received during timer recording, the unit enters Record Pause mode. Recording starts again if it is switched to a recordable broadcast during the time you programmed.

Satellite Receiver Users

To record a satellite broadcast using Manual Timer Programming:

- 1 Perform Manual Timer Programming.
- 2 Set the satellite receiver to the appropriate channel for recording.
 - Leave the satellite receiver's power on.

VPS/PDC Recording

Now available from some TV stations, PDC (Programme Delivery Control) and VPS (Video Programme System) are services designed to assure safe, accurate timer recording. With this system, special code signals are transmitted together with the audio/video signals. These code signals control your unit and have precedence over the advertised times you may have preset into the timer. This means that your unit will start and stop recording when the preset TV programmes actually start and end—even if the broadcast time of a preset TV programme is changed from what has been advertised. PDC is currently available nationally on BBC1, BBC2, Ch.4 and Ch.5, except from a few small relay transmitters. Ch.3 operates a PDC service in some areas. All channels intend to offer this service in due course. Check your TV programme listing guide for latest information. If the channel you intend to record does not offer a PDC service your unit will not start recording if PDC has been selected. Be sure to set PDC to "OFF" if PDC is not available on your selected channel. (See step 6 on page 38.).

NOTES:

- When you use Manual Timer Programming, set the start time (VPS or PDC time) exactly as advertised in the TV listing. A different time than advertised will result in no recording.
- VPS/PDC recording is also possible via the [L-1 IN/OUT] connector.

On-Disc Timer Programming



On-Disc Timer Programming is a function used with discs that are especially intended for a specific programme. The disc is then programmed for a programme you always watch every day or every week. Since older programmes are automatically overwritten, a single disc can be used without worrying about how much recording capacity remains. You can programme each disc to timer record as many as 8 programmes up to 30 days in advance.

- Make sure that the unit's built-in clock is set properly.
- Turn on the TV and select an input mode such as EXT1.
- Load a DVD-RAM or DVD-RW (VR mode) disc for programming.

ATTENTION:

- On-Disc Timer Programming is possible only with the disc for On-Disc Timer Programming.
- If data is recorded on a disc for On-Disc Timer Programming using a unit from another manufacturer, On-Disc Timer Programming may not function properly.

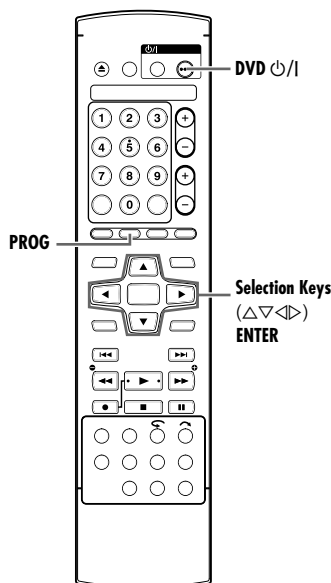

To Make The Disc For On-Disc Timer Programming

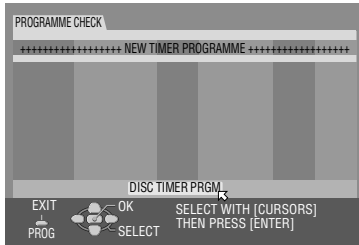
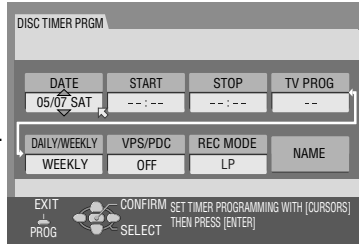
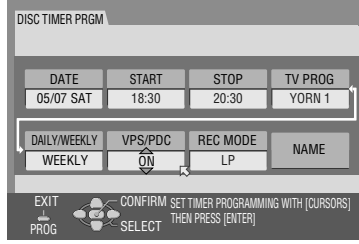
- 1 Press **PROG** to access the Programme Check screen.
 
- 2 Press **selection keys** to select "DISC TIMER PRGM", then press **ENTER**.
 - When some programmes are recorded on the disc, a caution message appears. You can either format the disc (pg. 70) or insert a new disc, then re-perform the procedure from step 1.
 - When On-Disc Timer Programming has already been made on the disc, press **selection keys** to select "NEW TIMER PROGRAMME", then press **ENTER**.
- 3 Press **selection keys** to set the desired date ("DATE"), then press **▷**.
 
- 4 Press **selection keys** to set the desired start time ("START"), then press **▷**.
 - Each press of **Δ▽** increases/decreases the start time in 1 minute interval.
 - To increase/decrease the start time in 30 minutes interval, press and hold **Δ▽**.
- 5 Press **selection keys** to set the desired stop time ("STOP"), then press **▷**.
 - Each press of **Δ▽** increases/decreases the stop time in 1 minute interval.
 - To increase/decrease the stop time in 30 minutes interval, press and hold **Δ▽**.
- 6 Press **selection keys** to set the desired channel ("TV PROG"), then press **▷**.
- 7 Press **selection keys** to set "DAILY/WEEKLY", then press **▷**.
 - For details on "DAILY/WEEKLY" setting, refer to "Daily/Weekly Recording Function" (pg. 38).
- 8 Set the other recording options as required.
 - "VPS/PDC Recording" (pg. 39)
 - "Recording Mode" (pg. 35)
 - "Modify Title Name" (pg. 47)
- 9 Press **ENTER** to access the Programme Confirmation screen.
 
- 10 Press **ENTER** to complete "To Make The Disc For On-Disc Timer Programming".
 - To programme another timer using "To Make The Disc For On-Disc Timer Programming", repeat steps 1 – 10.
- 11 Press **DVD P/I** to turn off the power.
 - **DISC** is displayed on the front display panel.
 - To disengage the timer mode, press **DVD P/I** again.

Satellite Receiver Users

To timer record a satellite broadcast using On-Disc Timer Programming:

- 1 Perform On-Disc Timer Programming.
- 2 Set the satellite receiver to the appropriate channel for recording.
 - Leave the satellite receiver's power on.

To Timer Record The Programme With The Programmed Disc

- 1 Load a programmed disc.
- 2 Press **DVD** \odot /I to turn off the power.
 - **DISC** \odot appears on the front display panel, and the unit enters into timer standby mode.
 - To disengage the timer mode, press **DVD** \odot /I again.

NOTES:

- On-Disc Timer Programming is not possible on a DVD-R or DVD-RW (Video mode) disc.
- The information of a programme recorded with On-Disc Timer Programming is not stored in the library.
- The play list is not created for the programmes recorded with On-Disc Timer Programming.
- Programmes recorded with On-Disc Timer Programming cannot be edited or protected.
- On-Disc Timer Programmed discs cannot be used for other recordings other than On-Disc Timer Programming.
- On-Disc Timer Programmed discs cannot be used on units from other manufacturers.
- The beginning of a programme may not be recorded. In addition, if the 1st programme's recording stop time and the 2nd programme's recording start time is the same, the ending of the 1st programme may not be recorded.
- If there is a power outage while recording, the recordings when the power outage occurs are not guaranteed.

How Discs Are Overwritten

(Example 1)

To record a 1-hour serial drama every Friday in SP mode

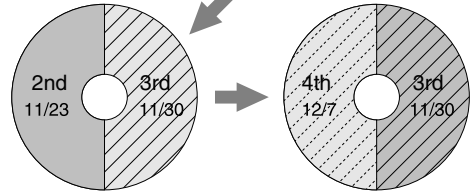
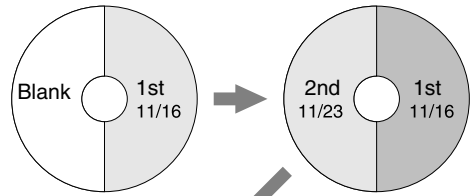

The first programme is overwritten by the third.

The second programme is overwritten by the fourth.

(Example 2)

To record a 15-minutes serial drama every morning in XP mode

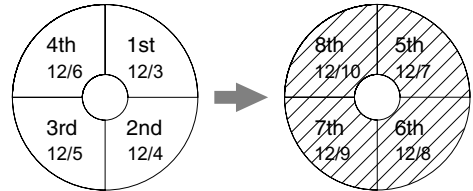

(Example 3)

To record a 90-minutes serial drama every Sunday in SP mode

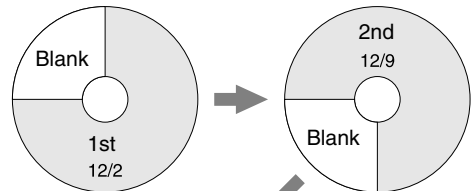

Areas treated as blank cannot be played back even if they contain recorded material.

NOTES:

- On-Disc Timer Programming may not always work as these examples.
- On-Disc Timer Programming may not complete successfully if the recording stop time is extended due to VPS/PDC.

Check, Cancel And Change Programmes

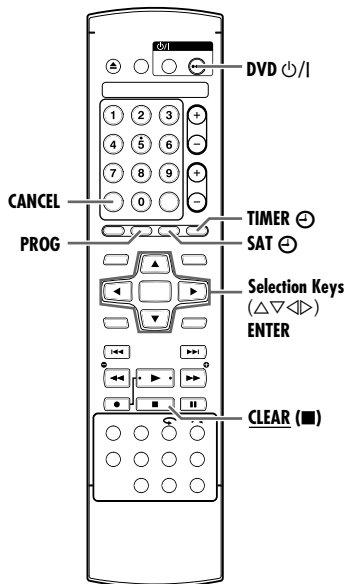

1 Disengage the timer mode.

- When **DISC** (Ⓜ) lights up on the front display panel, press **DVD** (Ⓜ/I).
- When (Ⓜ) lights up on the front display panel, press **TIMER** (Ⓜ), and press **DVD** (Ⓜ/I) after (Ⓜ) lights off.
- When "SAT (Ⓜ)" lights up on the front display panel, press **SAT** (Ⓜ).

2 Press **PROG** to access the Programme Check screen.

- To return to the previous screen after you check the programme, press **PROG** again.

To cancel the programme

- Press **selection keys** to select a programme to be cancelled, then press **CANCEL**.
- Press **selection keys** to select a programme to be changed, then press **ENTER**.
- Change the settings of the desired recording options as required.
 - Refer to steps 4 – 10 in Manual Timer Programming.
- Press **PROG** to exit the programme screen.
- Set the unit to timer standby mode.

For VIDEO Plus+ or Manual Timer Programming

- Press **TIMER** (Ⓜ) so that (Ⓜ) lights up on the front display panel.

For On-Disc Timer Programming

- Press **DVD** (Ⓜ/I) so that **DISC** (Ⓜ) lights up on the front display panel.

For Automatic Satellite Programme Recording

- Press **SAT** (Ⓜ) for 2 or more seconds.

When Programmes Overlap Each Other

If "PROGRAMME OVERLAPPED" appears, you have another programme overlapping the programme you have just made. Press **PROG**. Programme Check screen appears and conflicting programmes will be highlighted in pink.

Example: Programme 3 (you have just made) and Programme 4 overlap each other.

PROGRAMME CHECK						
DATE	START-STOP	TV PROG	DAILY/WEEKLY	VPS/PGC	REC MODE	
05/07 SAT	18:10-20:00	L-1		ON	SP	
06/01 THU	18:10-20:00	L-1		ON	SP	
10/07 THU	19:00-20:00	7	WEEKLY	OFF	XP	
10/07 THU	19:45-20:30	7		OFF	LP	
***** NEW TIMER PROGRAMME *****						
DISC TIMER PRGM.						
EXIT	OK	SELECT WITH [CURSORS]				
PROG	SELECT	THEN PRESS [ENTER]				

- 1 Confirm the overlapping programmes.

NOTES:

- If you do not mind this overlap, press **PROG** to finish the timer programme setting.
- Recording is performed according to the order as displayed on the Programme Check screen. The timer programme that follows will not be performed correctly.

To cancel the programme

Press **selection keys** to select a programme to be cancelled, then press **CLEAR** (■).

- "THE TIMER PROGRAMMING SETTING WAS CANCELLED" appears on the TV screen for about 5 seconds, then the normal screen resumes.

To change the programme

Press **selection keys** to select a programme to be changed, then press **ENTER**.

- Change each setting as required.

- 2 Press **ENTER** to exit the Programme screen.

- 3 Press **TIMER** (Ⓜ) to enter into timer standby mode.

NOTE:

When any overlaps remain after deletion and modification of programmes, Programme Overlap list remains showing the conflicting programmes. In such a case, repeat the procedure above until the conflict is solved.

Automatic Satellite Programme Recording

This function allows you to automatically record a satellite programme which is timer programmed on your external satellite receiver. Connect a satellite receiver to the unit's [L-2 IN/DECODER] connector and programme the timer on the satellite receiver. The unit starts or stops recording by the signals input from the satellite receiver. After recording, the unit's power shuts off automatically.

ATTENTION:

- When you record programmes by connecting to a digital terrestrial receiver (Freeview receiver or similar), perform the same steps as "Automatic Satellite Programme Recording" (pg. 43).
- Be sure not to turn on the satellite receiver before the programme is executed. Otherwise, the unit will start recording when the satellite receiver's power is turned on.
- If you have connected another appliance other than a satellite receiver to the [L-2 IN/DECODER] connector, be sure not to engage the Automatic Satellite Programme Recording mode. Otherwise, the unit will start recording when the connected appliance's power is turned on.
- Automatic Satellite Programme Recording and timer recording cannot be done at the same time.

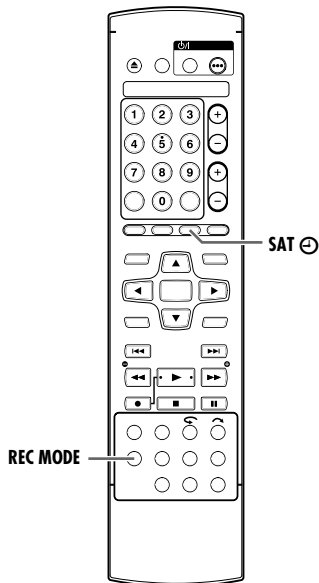

- Make sure the satellite receiver is connected to the unit's [L-2 IN/DECODER] connector.
- Programme the timer on the satellite receiver.

- 1 Set "L-2 SELECT" to "SAT VIDEO/RGB" or "SAT S-VIDEO/RGB". (pg. 59)
 - Also refer to "IMPORTANT" on page 60.
- 2 Press **REC MODE** repeatedly to set the recording mode.
- 3 Press and hold **SAT** for about 2 seconds to engage the Automatic Satellite Programme Recording mode. "SAT" and "⏏" appear on the front display panel and the unit turns off automatically.

NOTES:

- To disengage the Automatic Satellite Programme Recording mode, press **SAT**.
- If the unit's power is off, it is not possible to engage the Automatic Satellite Programme Recording mode.
- In step 3, if "⏏" blinks quickly on the front display panel even though your satellite receiver's power is off, Automatic Satellite Programme Recording will not work properly with that satellite receiver*. If this is the case, perform "Manual Timer Programming" (pg. 39) to timer record a satellite programme.

** Some satellite receivers output signals even if the power is off. Automatic Satellite Programme Recording is not possible with those satellite receivers.*
- "⏏" blinks on the front display panel while Automatic Satellite Programme Recording is in progress.
- For timer programming of the satellite receiver, refer to the instruction manual of the satellite receiver.
- Automatic Satellite Programme Recording is not possible if your satellite receiver does not have a timer.
- Pressing the unit's **⏏** button while Automatic Satellite Programme Recording is in progress turns off the unit's power and disengages the Automatic Satellite Programme Recording mode.
- If there are more than one satellite programmes you wish to record with Automatic Satellite Programme Recording, it is not possible to set different recording modes for each programme.
- Depending on the type of satellite receiver, the unit may not record a slight portion of the beginning of the programme or may record slightly longer than the actual length of the programme.
- If you engage the Automatic Satellite Programme Recording mode when the satellite receiver's power is on, the unit will not start Automatic Satellite Programme Recording even though "⏏" blinks on the front display panel. When the satellite receiver shuts off once and is turned back on again, the unit starts recording.
- When the Automatic Satellite Programme Recording mode is engaged, or the unit's power is turned off after Automatic Satellite Programme Recording is finished, the unit will not enter the timer mode even though "AUTO TIMER" is set to "ON".
- Just Clock (pg. 69) does not work when the Automatic Satellite Programme Recording mode is engaged.

Library Database Navigation



The Library Database Navigation enables you to search and select the desired titles recorded very easily.

You can record up to 99 titles on a disc.

Each time a title is recorded, the information of the title is registered for the Library Database Navigation automatically. So, you can confirm the information of the titles recorded with the Library Database Navigation screen. And, you can also select one of the titles recorded using the Library Database Navigation.

The following screen appears as the Library Database Navigation screen when you press **NAVIGATION**. You can move the arrow to select the desired position on the screen by pressing the **selection keys** on the remote control.

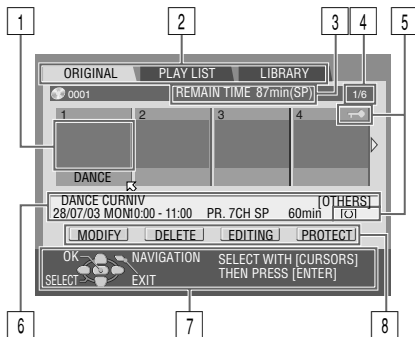

- 1 INDEX
(Thumbnail of each programme)
- 2 Menu index
ORIGINAL (pg. 45)
PLAY LIST (pg. 48)
LIBRARY (pg. 52)
- 3 Remaining time
(Based on the recording speed currently selected)
- 4 Current/Total number of programme(s)
- 5 Icons
- 6 Recording information for the programme indicated by the arrow
- 7 Guidance for operations
- 8 Operational commands

The Icons and their meanings

	This programme is write-protected.
	This programme has stereo sounds.
	This programme has monaural sounds.
	This programme has bilingual sounds.
	This programme was recorded with timer recording.

Using Library Database Navigation system, you can easily modify registered information, edit the title or play list, as well as search for the beginning of each title.

About registration of information

The following information is automatically registered for each title when ordinary recording or timer recording is performed, then stored in an area specified on the unit.

- index* (reduced pictures to show programme titles)
- programme title*
- category*
- date and time
- channel
- recording mode
- length of recording time

The items marked with an asterisk (*) can be easily modified and registered again after recording by using Library Database Navigation system.

The limitations of registration

You can register information up to 99 programmes in a single DVD.

When the amount of information is at the limits of registration, you cannot record new titles any more. In this case, you need to delete old titles to register new ones. (pg. 45)

NOTES:

- Once a DVD-R/RW (Video mode) disc has been finalised, the displays for original and play list do not appear. As only display for library appears, press **TOP MENU** to display the following screen to select the desired title.

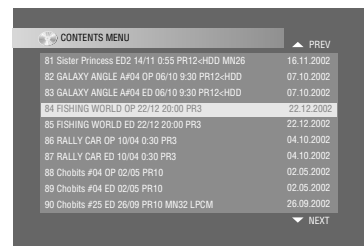

- Sound of received channel may be interrupted while the Library Database Navigation screen is displayed.
- You cannot perform timer recording during editing of thumbnail images or play lists by pressing **NAVIGATION**. Press **NAVIGATION** to clear the editing screen before performing timer recording.

Basic Operation Of Original Information

You can scan the beginning of the title easily and play back with the Library Database Navigation.

- Turn on the TV and select an input mode such as EXT1.
- Load a DVD disc to play back.

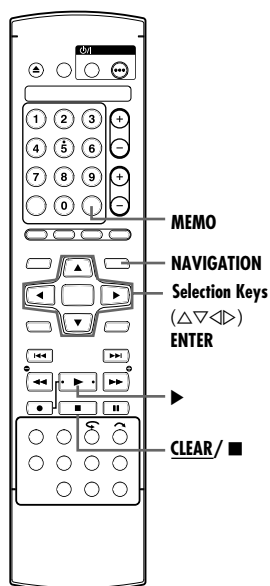

Play Back Title

- 1 Press **NAVIGATION** to display the Library Database Navigation screen.
- 2 Press **selection keys** to select "ORIGINAL", then press **ENTER**.
- 3 Press **selection keys** to select the index (small pictures) of the desired title, then press **ENTER** or **▶**.
 - With the arrow on "ORIGINAL", all titles will be played back according to the index order when **▶** is pressed.
 - All subsequent titles after the selected index will be played back in order.
 - The unit stops when playback ends, and resumes to a broadcast receiving screen.
 - Press **■** to stop playback. If "RESUME" is set to "ON" or "DISC RESUME" (pg. 63), playback starts from the point where playback was previously stopped when **▶** is pressed.
 - When you want multiple titles to be played back in a determined order, press **selection keys** to select the desired title, then press **MEMO**. The numbers of the playback order appear on the index. (Up to 30 titles)
 - When you want to correct the order, move the arrow to the desired index and press **MEMO**. The number disappears and the unit re-numbers the other titles automatically.
 - When you want to cancel the order, press **CLEAR(■)**.

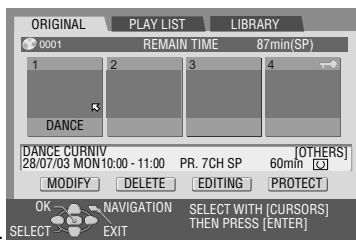

Protect Title (DVD-RAM & DVD-RW (VR mode) only)

You can protect titles to prevent accidental erasure of the important titles.

- 1 Press **NAVIGATION** to display the Library Database Navigation screen.
- 2 Press **selection keys** to select "ORIGINAL", then press **ENTER**.
- 3 Press **selection keys** to select a title you want to protect, then press **▽**.
- 4 Press **selection keys** to select "PROTECT", then press **ENTER**.
 - "PROTECT" appears on the TV screen.
 - To cancel the protection, select "PROTECT" again, then press **ENTER**.
- 5 Press **NAVIGATION** to return to the normal screen.

NOTE:

All the titles on a disc will be deleted once the disc is formatted even if they are protected titles. (pg. 70)

Delete Title

You cannot record any more with Library Database Navigation once the registered titles on the disc reach 99 titles. Deleting unnecessary titles after dubbing or other operations can increase remaining time and available recording capacity. (For DVD-R discs, although it is possible to delete recorded titles, available recording capacity does not increase.) The deleted title cannot be retrieved. Play lists and title information in the unit's library are also deleted.

- 1 Press **NAVIGATION** to display the Library Database Navigation screen.
- 2 Press **selection keys** to select "ORIGINAL", then press **ENTER**.
- 3 Press **selection keys** to select a title you want to delete, then press **▽**.
- 4 Press **selection keys** to select "DELETE", then press **ENTER**.
 - The confirmation screen appears.
- 5 Press **selection keys** to select "YES", then press **ENTER**.
 - To cancel the deletion, select "NO", then press **ENTER**.
- 6 Press **NAVIGATION** to return to the normal screen.

Delete Unwanted Part Of The Title (DVD-RAM & DVD-RW (VR mode) only)

You can delete unwanted part of a title.

- 1 Press **NAVIGATION** to display the Library Database Navigation screen.
- 2 Press **selection keys** to select "ORIGINAL", then press **ENTER**.
- 3 Press **selection keys** to select a title whose unwanted part you want to delete, then press **▽**.
- 4 Press **selection keys** to select "EDITING", then press **ENTER**.
- 5 Press **▶** to start playback.
 - Press **◀◀** or **▶▶** to find the point where you want the deletion to begin, then press **II**.
- 6 Confirm the arrow is on "IN", then press **ENTER**.
 - The edit-in time is displayed on the left of the "IN" window.
- 7 Press **▶** to resume playback.
 - Press **II** to pause at the point where you want the deletion to end.
- 8 Confirm the arrow is on "OUT", then press **ENTER**.
 - The edit-out time is displayed on the left of the "OUT" window.
- 9 Press **selection keys** to select "PREVIEW", then press **ENTER** to preview the edited title.

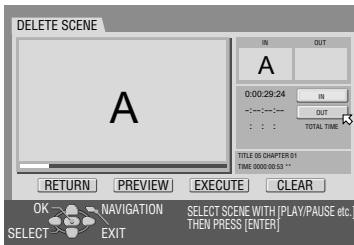
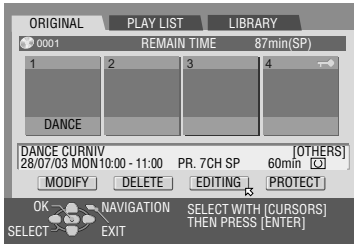

To modify the points

- 1 Press **selection keys** to select "CLEAR", then press **ENTER**.
 - Press **selection keys** to select "RETURN", then press **ENTER** to return to the screen in step 4.
- 2 Press **selection keys** to select "IN".
- 3 Perform steps 5 – 9.
- 10 Press **selection keys** to select "EXECUTE", then press **ENTER**.
 - The confirmation screen appears.
- 11 Press **selection keys** to select "YES", then press **ENTER**.
 - When you cancel the deletion, select "NO", then press **ENTER**.
- 12 Press **NAVIGATION** to return to the normal screen.

NOTES:

- There may be a discrepancy of several seconds between the scene you intend to edit, and the scene which is actually edited.
- Available recording capacity may not match the deleted part after deletion.

Edit Original Information



- Turn on the TV and select an input mode such as EXT1.
- Load a DVD disc to modify.

ATTENTION:

- It is not possible to modify discs recorded on DVD units from other manufacturers.
- You cannot perform timer recording during editing of index by pressing **NAVIGATION**. Press **NAVIGATION** to clear the editing screen before performing timer recording.

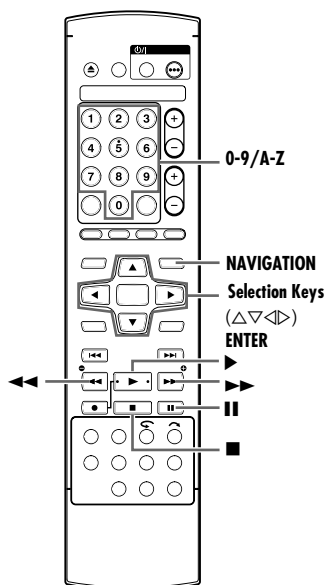

Modify Index

- 1 Press **NAVIGATION** to display the Library Database Navigation screen.
- 2 Press **selection keys** to select "ORIGINAL", then press **ENTER**.
- 3 Press **selection keys** to select a title you want to modify, then press **▽**.
- 4 Press **selection keys** to select "MODIFY", then press **ENTER**.
- 5 Press **selection keys** to select "MODIFY INDEX", then press **ENTER**.
- 6 Press **▶** to start playback. Press **◀◀** or **▶▶** to search for the picture from the title, then press **II**.
- 7 Confirm the arrow is on "REPLACE", then press **ENTER**.
 - The new index appears on the right window.
- 8 Confirm the arrow is on "RETURN", then press **ENTER**.
 - You can confirm the new index.
- 9 Press **NAVIGATION** to return to the normal screen.

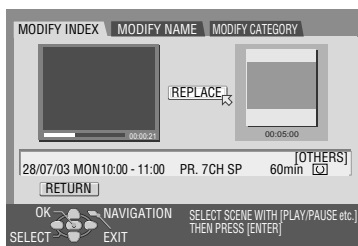

Modify Title Name

- 1 Perform steps 1 – 4 of "Modify Index" (pg. 47) before continuing.
- 2 Press **selection keys** to select "MODIFY NAME", then press **ENTER**.
- 3 Input a new title name.
 - Press **selection keys** to select the desired letter or symbol, then press **ENTER**.
 - To erase the letter, press **selection keys** to select "DELETE" or "DELETE ALL", then press **ENTER**.
 - You can enter up to 64 letters.
 - You can also use the **number keys** on the remote control to input the letters. For example, pressing the **number key "2"** repeatedly changes the letter in the order of "A", "B", "C", "a", "b", "c" and "2". The following buttons can also be used.

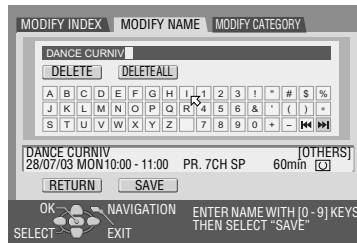

- Number keys: To input alphabet, numbers and space.
- ◀▶ buttons: To move the input position and insertion point.
- button: To correct the letters.
- ◀◀▶▶ buttons: To switch the character table.

- 4 Press **selection keys** to select "SAVE", then press **ENTER**.
 - The new title name is registered.
- 5 Press **selection keys** to select "RETURN", then press **ENTER**.
 - Return to the Library Database Navigation screen to confirm the modified name.
- 6 Press **NAVIGATION** to return to the normal screen.

Modify Category

- 1 Perform steps 1 – 4 of "Modify Index" (pg. 47) before continuing.
- 2 Press **selection keys** to select "MODIFY CATEGORY", then press **ENTER**.
- 3 Press **selection keys** to select the desired category, then press **ENTER**.
- 4 Press **selection keys** to select "RETURN", then press **ENTER**.
 - Return to the Library Database Navigation screen to confirm the modified category.
- 5 Press **NAVIGATION** to return to the normal screen.

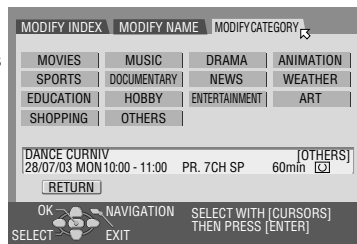

Basic Operation Of Play List Information



Play List

It is a collection of the scenes. A play list can be freely edited and played back without ever changing any original recording data. Using the random access of a disc (which allows video data to be instantly read no matter where it is on the disc), a play list includes information such as the timer counter for the playback start point and end point, indexes for checking the contents of recorded data, category information, and more. Playback according to a play list you have created allows you to enjoy various combinations of video images from a single title.

- Turn on the TV and select an input mode such as EXT1.
- Load a DVD disc to modify.

ATTENTION:

It is not possible to modify discs recorded on DVD units from other manufacturers.

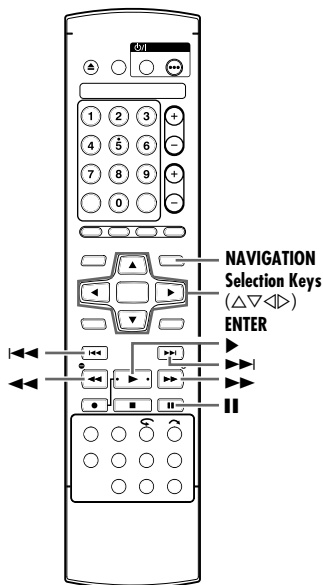

Create Play List

- 1 Press **NAVIGATION** to display the Library Database Navigation screen.
- 2 Press **selection keys** to select "PLAY LIST", then press **ENTER**.
- 3 Press **selection keys** to select "CREATE", then press **ENTER**.

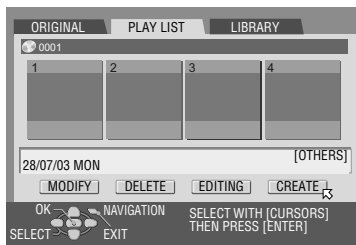

- 4 Press **▶** to start playback.
 - To move to other titles, press **◀◀** or **▶▶**.
 - Press **◀◀** or **▶▶** to find the point where you want the created play list to begin, then press **||**.

- 5 Confirm the arrow is on "IN", then press **ENTER**.
 - The edit-in time is displayed on the left of the "IN" window.

- 6 Press **▶** to resume playback.
 - Press **||** to pause at the point where you want the created play list to end.

- 7 Confirm the arrow is on "OUT", then press **ENTER**.
 - The edit-out time is displayed on the left of the "OUT" window.
 - The edit-out point must come after the edit-in point.
- 8 Press **selection keys** to select "PREVIEW", then press **ENTER** to preview the play list.
 - To cancel play list creation, press **selection keys** to select "RETURN", then press **ENTER**.

To modify the points

- 1 Press **selection keys** to select "CLEAR", then press **ENTER**.
- 2 Press **selection keys** to select "IN".
- 3 Perform steps 4 – 8.
- 9 Press **selection keys** to select "EXECUTE", then press **ENTER**. The play list is created.

- 10 Press **NAVIGATION** to return to the normal screen.

NOTES:

- There may be a discrepancy of several seconds between the scene you intend to edit, and the scene which is actually edited.
- The title, index and category of the play list can be modified in the same way as "ORIGINAL". (pg. 47)
- You can modify the play list that has just been created here by adding, moving, or deleting unwanted parts to create a digest edition, etc.

Play Back Play List

- 1 Press **NAVIGATION** to display the Library Database Navigation screen.
- 2 Press **selection keys** to select "PLAY LIST", then press **ENTER**.
- 3 Press **selection keys** to select a play list to be played back, then press **ENTER**.
 - The unit stops when playback ends, and resumes to a broadcast receiving screen.
 - When you want the multiple play lists to be played back continuously, press **MEMO** after selecting the desired play lists. The numbers of the playback order appear on the index. (Up to 30 titles)

Delete Play List

- 1 Press **NAVIGATION** to display the Library Database Navigation screen.
- 2 Press **selection keys** to select "PLAY LIST", then press **ENTER**.
- 3 Press **selection keys** to select a play list you want to delete, then press **▽**.
- 4 Press **selection keys** to select "DELETE", then press **ENTER**.
 - The confirmation screen appears.
- 5 Press **selection keys** to select "YES", then press **ENTER**.
 - To cancel the deletion, select "NO", then press **ENTER**.
- 6 Press **NAVIGATION** to return to the normal screen.

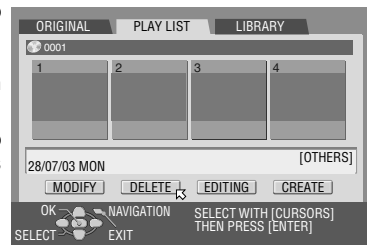
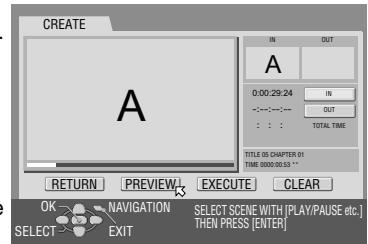

Edit Play List Information



- Turn on the TV and select an input mode such as EXT1.
- Load a DVD disc to modify.

ATTENTION:

It is not possible to modify discs recorded on DVD units from other manufacturers.

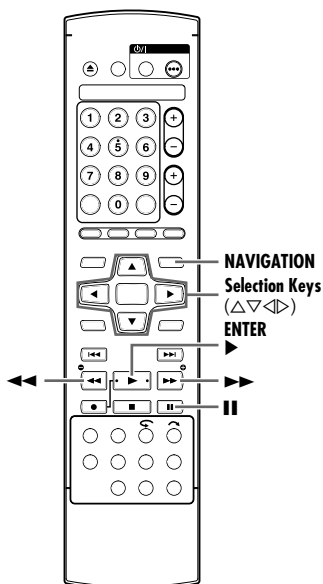

Modify Index

- 1 Press **NAVIGATION** to display the Library Database Navigation screen.
- 2 Press **selection keys** to select "PLAY LIST", then press **ENTER**.
- 3 Press **selection keys** to select a play list you want to modify, then press **▽**.
- 4 Press **selection keys** to select "MODIFY", then press **ENTER**.
- 5 Press **selection keys** to select "MODIFY INDEX", then press **ENTER**.
- 6 Press **▶** to start playback. Press **◀◀** or **▶▶** to search for the picture from the title, then press **||**.
- 7 Confirm the arrow is on "REPLACE", then press **ENTER**.
 - The new index appears on the right window.
- 8 Confirm the arrow is on "RETURN", then press **ENTER**.
 - You can confirm the new index.
- 9 Press **NAVIGATION** to return to the normal screen.

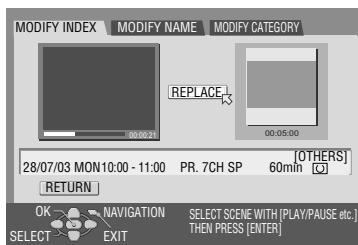
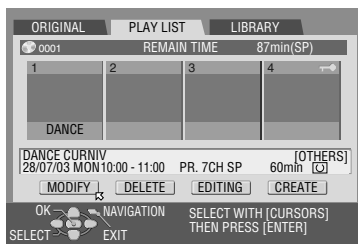

Modify Play List Name

- 1 Perform steps 1 – 4 of "Modify Index" (pg. 49) before continuing.
- 2 Press **selection keys** to select "MODIFY NAME", then press **ENTER**.
- 3 Input a new title name. See "Modify Title Name" (pg. 47).
- 4 Press **selection keys** to select "SAVE", then press **ENTER**.
- 5 Press **selection keys** to select "RETURN", then press **ENTER**.
 - Return to the Library Database Navigation screen to confirm the modified name.
- 6 Press **NAVIGATION** to return to the normal screen.

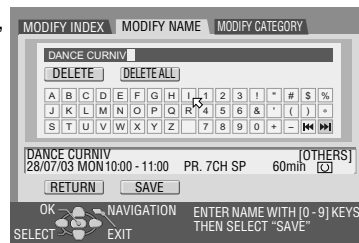

Modify Category

- 1 Perform steps 1 – 4 of "Modify Index" (pg. 49) before continuing.
- 2 Press **selection keys** to select "MODIFY CATEGORY", then press **ENTER**.
- 3 Press **selection keys** to select the desired category, then press **ENTER**.
- 4 Press **selection keys** to select "RETURN", then press **ENTER**.
 - Return to the Library Database Navigation screen to confirm the modified category.
- 5 Press **NAVIGATION** to return to the normal screen.

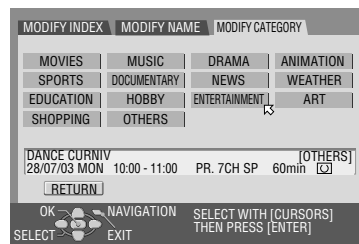

Delete Scenes

- 1 Press **NAVIGATION** to display the Library Database Navigation screen.
- 2 Press **selection keys** to select "PLAY LIST", then press **ENTER**.
- 3 Press **selection keys** to select a play list from which you wish to delete unwanted scenes, then press ∇ .
- 4 Press **selection keys** to select "EDITING", then press **ENTER**.
- 5 Press **selection keys** to select "DELETE SCENE", then press **ENTER**.
- 6 Press \blacktriangleright to start playback.
 - Press \blacktriangleleft or \blacktriangleright to find the point where you want the deletion to begin, then press **II**.
- 7 Confirm the arrow is on "IN", then press **ENTER**.
 - The edit-in time is displayed on the left of the "IN" window.
- 8 Press \blacktriangleright to resume playback.
 - Press **II** to pause at the point where you want the deletion to end.
- 9 Confirm the arrow is on "OUT", then press **ENTER**.
 - The edit-out time is displayed on the left of the "OUT" window.
- 10 Press **selection keys** to select "PREVIEW", then press **ENTER**. A preview of the scene approximately 5 seconds before and after the deleted part is played back.
 - To cancel the deletion, press **selection keys** to select "RETURN", then press **ENTER**.

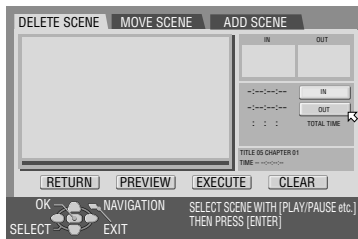
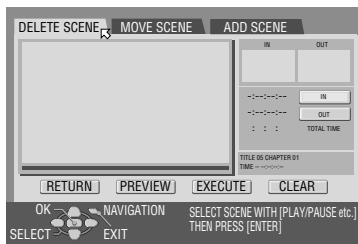
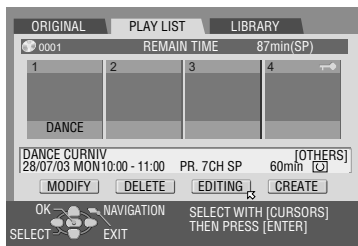

Move Scenes

- 1 Press **NAVIGATION** to display the Library Database Navigation screen.
- 2 Press **selection keys** to select "PLAY LIST", then press **ENTER**.
- 3 Press **selection keys** to select a play list which you wish to move a scene, then press ∇ .
- 4 Press **selection keys** to select "EDITING", then press **ENTER**.
- 5 Press **selection keys** to select "MOVE SCENE", then press **ENTER**.
- 6 Press \blacktriangleright to start playback.
 - Press \blacktriangleleft or \blacktriangleright to find the point where you want the moved scene to begin, then press **II**.
- 7 Confirm the arrow is on "IN", then press **ENTER**.
 - The edit-in time is displayed on the left of the "IN" window.
- 8 Press \blacktriangleright to start playback.
 - Press **II** to pause at the point where you want the moved scene to end.
- 9 Confirm the arrow is on "OUT", then press **ENTER**.
 - The edit-out time is displayed on the left of the "OUT" window.
- 10 Press \blacktriangleright to start playback.
 - Find the point where you want the moved scene to be moved, then press **II**.
- 11 Confirm the arrow is on "MOVE TO", then press **ENTER**.
- 12 Press **selection keys** to select "PREVIEW", then press **ENTER**. A preview of approximately 5 seconds before and after the point to which the scene has been moved is played back.
 - To cancel the moving, press **selection keys** to select "RETURN", then press **ENTER**.

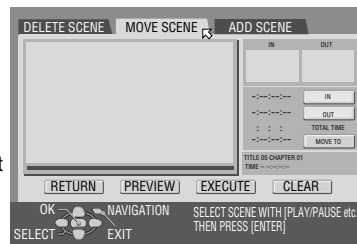
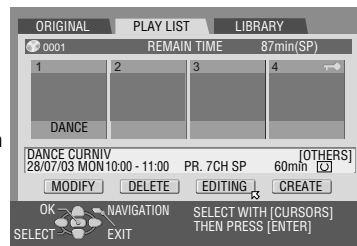

To modify the points

- 1 Press **selection keys** to select "CLEAR", then press **ENTER**.
- 2 Press **selection keys** to select "IN".
- 3 Perform steps 6 – 12.
- 13 Press **selection keys** to select "EXECUTE", then press **ENTER**.
- 14 Press **NAVIGATION** to return to the normal screen.

Add Scenes

- 1 Press **NAVIGATION** to display the Library Database Navigation screen.
- 2 Press **selection keys** to select "PLAY LIST", then press **ENTER**.
- 3 Press **selection keys** to select a play list to which you wish to add a scene, then press **▽**.
- 4 Press **selection keys** to select "EDITING", then press **ENTER**.
- 5 Press **selection keys** to select "ADD SCENE", then press **ENTER**.
- 6 Press **▶** to start playback.
 - To move to other titles, press **◀◀** or **▶▶**.
 - Press **◀◀** or **▶▶** to find the point where you want the created play list to begin, then press **II**.
- 7 Perform steps 5 – 10 of "Create Play List" (pg. 48).

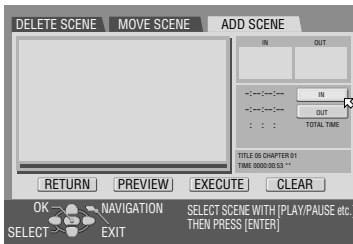
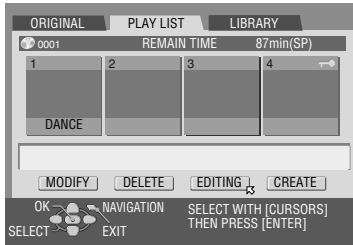

Edit Library Information



Each disc recorded on this unit is automatically numbered. If this number is retained, it is possible to find out the titles recorded in a disc quickly. Title information can be registered in the unit's memory for up to 1300 titles.

NOTE:

If you do not want the information to be registered in the library automatically, set "SAVE AS LIBRARY" to "OFF". (☞ pg. 62)

- Turn on the TV and select an input mode such as EXT1.

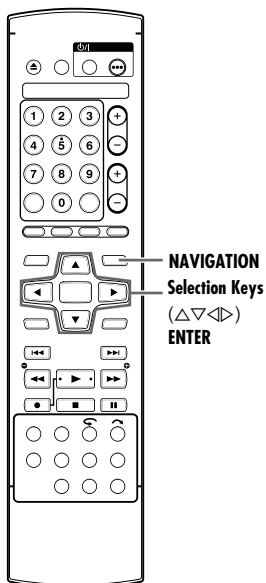

Scan For Title From Library

1 Press **NAVIGATION** to display the Library Database Navigation screen.

2 Press **selection keys** to select "LIBRARY", then press **ENTER**.

3 Select the appropriate sort button to sort the information, then press **ENTER**.

"DISC No.":

Sort by disc number.

"CATEGORY":

Sort by category.

"DATE":

Sort by date.

"NAME":

Sort by name.

- Each time when the sort button is selected and **ENTER** is pressed, the sorting order switches between ascending order and descending order.

4 Press **selection keys** to select the desired title, then press **ENTER**.

- If the DVD disc loaded on this unit contains the selected title, the selected title and all subsequent titles will be played back.

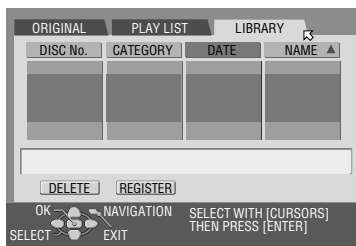

When the disc that contains the selected title is not loaded
A prompt screen appears. Load the disc after pressing **ENTER** to close the prompt screen.
Then perform steps **1** – **4**.

NOTE:

If a disc registered in the library is recorded or modified on DVD units from other manufacturers, it may become impossible to operate properly.

Register Disc

If a disc that is not registered in the library is loaded, a message confirming whether the disc should be registered appears when the Library Database Navigation screen is displayed. If registering, perform the following procedure.

1 Press **NAVIGATION** to display the Library Database Navigation screen.

2 Press **selection keys** to select "LIBRARY".

3 Press **selection keys** to select "REGISTER", then press **ENTER**.

- To quit registration, select "CANCEL", then press **ENTER**.

4 Press **NAVIGATION** to return to the normal screen.

NOTES:

- It is not possible to register discs used for On-Disc Timer Programming. (☞ pg. 40)
- It is not possible to register discs formatted on devices other than JVC's DVD recorders.
- It is not possible to register discs recorded on devices other than JVC's DVD recorders.

Delete Information

1 Perform steps **1** – **3** of "Scan For Title From Library" (☞ pg. 52) before continuing.

2 Press **selection keys** to select a title whose information you want to delete, then press **▽**.

3 Press **selection keys** to select "DELETE", then press **ENTER**.

- The confirmation screen appears.

4 Press **selection keys** to select "DELETE", then press **ENTER**.

- To cancel the information deletion, select "CANCEL", then press **ENTER**.

5 Press **NAVIGATION** to return to the normal screen.

Playback With MP3/JPEG Navigation



This unit can play back discs that MP3 sound files and JPEG image files taken with digital still cameras or other devices are recorded.

The MP3/JPEG Navigation enables you to search and select the desired files recorded on CD-R/RW or CD-ROM discs very easily.

- Turn on the TV and select an input mode such as EXT1.

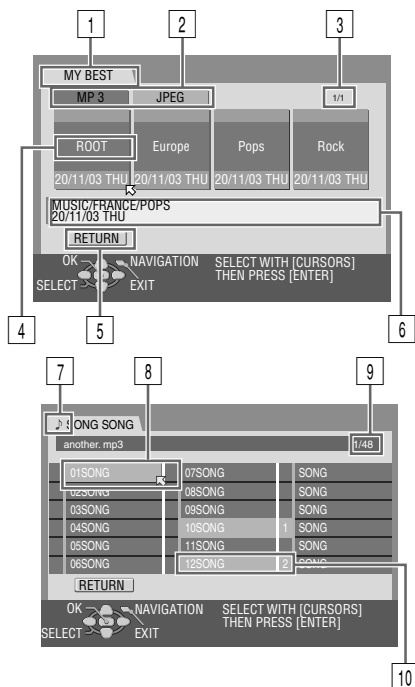

- 1 Name of the inserted disc
- 2 Sort buttons ("MP 3"/ "JPEG")
- 3 Selected group number/total number of groups on the disc
- 4 Group name
- 5 Return button
- 6 Group name/Created date
- 7 File type indicator
 🎵: MP3
 🖼️: JPEG
- 8 Selected file
- 9 Selected file number/total number of files in the group that contains the selected file
- 10 Programme number/file name

Locating The Desired Group And Tracks

- 1 Load a disc.
- 2 Press **NAVIGATION**.
- 3 Press **selection keys** to select "MP 3" or "JPEG", then press **ENTER**.
- 4 Press **selection keys** to select the desired group, then press **ENTER**.
 - A list of files in the selected group appears.
- 5 Press **selection keys** to select a file you want to play back, then press **ENTER**. The unit starts playback from the selected file.
 - Playback stops when all the files in the selected group are played back.

NOTES:

- If you press ▶ instead of **ENTER** in step 4, the unit starts playback from the first file of the group.
- JPEG files are played back as a slide show at the set intervals. (pg. 34)
- If a file name includes any 2 byte character, the unit may not show the file name correctly.
- The order of the groups and items shown in steps 4 and 5 may differ from the order shown on your PC.
- When you want the multiple files to be played back continuously, press **MEMO** instead of **ENTER** in step 5. Playbacks in the specified order when ▶ is pressed. (Up to 30 titles)
- If you have specified a wrong selection, press **CANCEL**. Or press **CLEAR**(■), all the title numbers are erased.

After all the files are played back

- 1 Perform steps 1 – 4.
- 2 Press **CLEAR**(■).
 - The title numbers are reset and erased.
- 3 Press **NAVIGATION** to return to the normal screen.

DV Dubbing

You can dub programmes from a camcorder or DV equipment connected to the unit with a DV cable. The unit's remote control allows you the limited control of the connected camcorder or DV equipment functions during dubbing.

NOTES:

- Use the DV cable VC-VDV 204U for connection.
- When you connect a PC to the [DV IN] connector, we do not assure the normal operation of this unit.

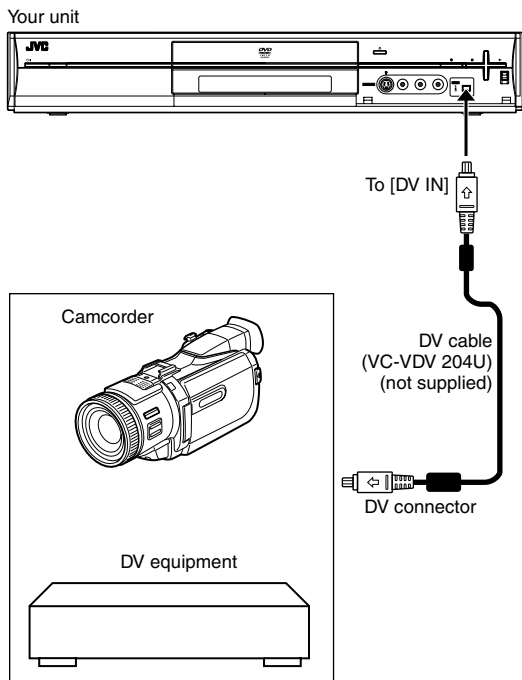

The following on-screen display for DV dubbing appears when **ON SCREEN** is pressed while the channel has been set to "DV".

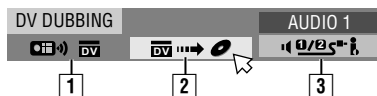

1 DV dubbing controller

If this mark is not displayed, check whether the DV equipment has been connected to the unit.

2 Auto capture button

Select to start or pause the dubbing. If **ENTER** is pressed when the DV device is in the pause condition, preroll editing* where it is possible to dub with a start time that is highly accurate will be activated. When the DV device cannot be operated from the unit (such as in camera mode), proceed with normal recording (pg. 35).

* Preroll editing refers to the playback after the DV tape is slightly rewind. (For DV devices that do not support the $-1x$ speed, the rewinding time may be longer.)

3 Sound monitor switch

For selecting the desired sound format for dubbing.

1 Connect a camcorder or DV equipment to the [DV IN] connector on the unit's front panel.

2 Press **PR +/-** to set the channel to "DV".

- The on-screen display for DV dubbing appears.

3 Press **REC MODE** repeatedly to set the recording mode.

4 Locate the point from where you want to start dubbing, then stop or pause playback by pressing the following buttons on the remote control: **▶▶▶**, **◀◀◀**, **■**, **||**.

- To play back in slow speed (1/10 of the normal speed), press **||** to pause playback, then press **◀◀◀** or **▶▶▶**.
- To play back frame-by-frame, press **||** to pause playback, then press **||** repeatedly. Each press of **||** advances a frame.
- To change the playback direction, press **◀◀◀** or **▶▶▶**.

5 Press **selection keys** to select **AUDIO 1**, then press **ENTER**. Select the desired sound track from the pull-down menu, then press **ENTER**.

AUDIO 1:

Select this to record the original stereo sound played back on the connected DV equipment.

AUDIO 2:

Select this to record the dubbed stereo sound played back on the connected DV equipment.

MIX:

Select this to record the sound of both "AUDIO 1" and "AUDIO 2".

- Note that this selection is not available when the source programme is recorded in 16BIT (48 kHz) mode.

6 Press **selection keys** to select **DV DUBBING**, then press **ENTER**. The dubbing starts.

- Playback on the external DV equipment and recording on the unit should start simultaneously.
- To pause dubbing, press **selection keys** to select **DV DUBBING**, then press **ENTER**. Both the unit and the external DV equipment pause dubbing.
- To resume dubbing, press **selection keys** to select **DV DUBBING**, then press **ENTER** to start dubbing.

7 Press **■** to stop dubbing.

- Both the unit and the external DV equipment stop dubbing.

NOTES:

- Dubbing copyright guarded programmes is not possible.
- Original DV information such as the recording date and time are not recorded.
- The superimposed indication during the operation or dubbing is not recorded.
- If the dubbing is paused while the channel is set to "DV", you cannot switch channels.
- Only DV format video can be dubbed. It is not possible to dub MPEG2 format video.

When you dub from DV equipment other than a camcorder

- 1 Perform steps 1 – 3.
- 2 Locate the point from where you want to start dubbing, then stop on the DV equipment.
 - If you pause the DV equipment in this step, a few second's still picture will be recorded at the beginning of the recorded programme.
- 3 Set the input mode to "DV INPUT" on the DV equipment.
 - If input mode is set to other than "DV INPUT", unwanted pictures may be recorded at the beginning of the recorded programme.
- 4 Perform steps 6 and 7.

To skip unwanted part of the source picture

Press **ENTER** to stop both equipment, press **▶**, **▶▶** or **◀◀** to locate the point where you want to resume dubbing, then press **■**.

- Press **selection keys** to select , then press **ENTER** to start dubbing.

Digital Audio Dubbing

You can dub selected audio from a DVD or Audio CD disc to a digital audio device.

However, it is not possible to dub copy-protected discs.

- Turn on the TV and select an input mode such as EXT1.

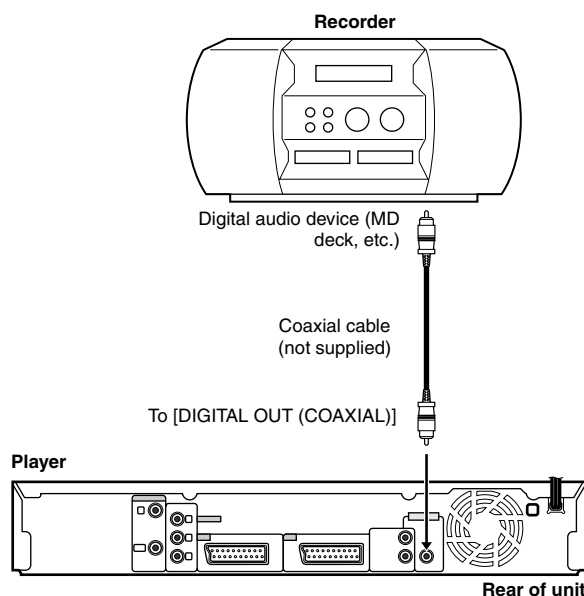
Example: Dubbing to an MD

- 1 Connect the unit and a digital audio device using an optional coaxial cable.
- 2 Place a disc on the unit and load an MD on the connected digital audio device.
- 3 Select the audio to be dubbed.
- 4 Start playback slightly before the actual point from where you wish to start dubbing.
- 5 Press **||** to pause playback.
- 6 Select the input mode on the connected digital audio device.
- 7 Press **▶** to start playback on the unit.
- 8 Start recording on the digital audio device.
- 9 Stop recording on the digital audio device. Then press **■** to stop playback on the unit.

NOTE:

There may be a discrepancy of several seconds between where you intend editing to start, and where it actually starts.

Edit From A Camcorder

You can use a camcorder as the source player and your unit as the recording deck.

1 If the camcorder has no S-VIDEO output connector:

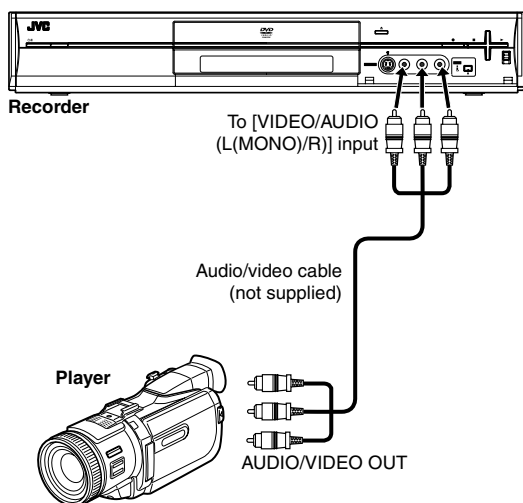

2 If the camcorder has an S-VIDEO output connector:

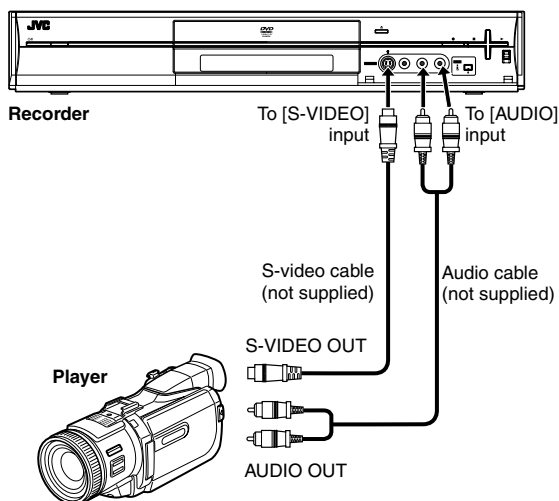

1 Make connections.

- 1 If the camcorder has no S-VIDEO output connector:
 - connect the camcorder's AUDIO/VIDEO OUT connectors to the unit's [VIDEO/AUDIO (L(MONO)/R)] input connectors on the front panel.
 - When using a monaural camcorder, connect its AUDIO OUT connector to the [AUDIO(L(MONO))] input connector on your unit.
- 2 If the camcorder has an S-VIDEO output connector:
 - connect the camcorder's AUDIO and S-VIDEO OUT connectors to the unit's [AUDIO (L(MONO)/R)] and [S-VIDEO] input connectors on the front panel.

2 Press **PR +/-** to select "F-1".

- Set "F-1 INPUT" to "VIDEO" for the [VIDEO] input connector, or "S-VIDEO" for the [S-VIDEO] input connector, depending on the connector being used. (pg. 59)

3 Press **REC MODE** repeatedly to set the recording mode.

4 Start playback on the camcorder slightly before the actual point from where you wish to start dubbing.

5 Press **●** on the unit to start recording. Or while holding **●**, press **▶** on the remote control. The dubbing starts.

6 Upon completing dubbing, stop the unit and the camcorder.

- Stop recording on the recording deck (your unit), then stop playback on the source player (camcorder).

NOTES:

- All necessary cables can be obtained from your dealer.
- Refer to the camcorder's instruction manual for operating procedure.
- The quality of the dubbed picture is poorer than that of the original.

Edit To Or From Another Recorder

You can use your unit as the source player or as the recording deck.

NOTE:

When using another recorder as the recording deck, refer to its instruction manual.

1 When using your unit as the source player

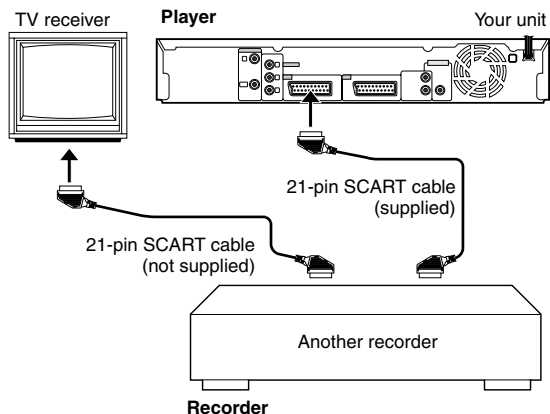

2 When using your unit as the recording deck

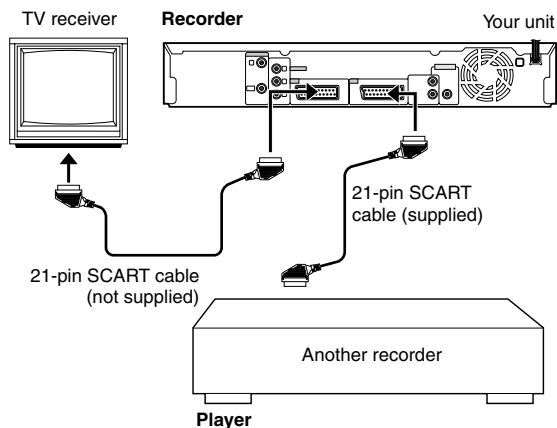

1 Connect another recorder's 21-pin SCART connector to the unit's 21-pin SCART connector as illustrated.

- 1 When using your unit as the source player:
 - connect its [L-1 IN/OUT] connector to the recording deck.
- 2 When using your unit as the recording deck:
 - connect its [L-2 IN/DECODER] connector to the source player.
 - If another recorder is compatible with the Y/C signal:
 - when using your unit as the source player, set "L-1 OUTPUT" to "SCART S-VIDEO". (pg. 58)
 - when using your unit as the recording deck, set "L-2 SELECT" to "S-VIDEO/RGB". (pg. 59)

2 When using this unit as the recording deck, press **PR +/-** to select "L-2".

- Set "L-2 SELECT" to "VIDEO/RGB" or "S-VIDEO/RGB". (pg. 59)

3 When using this unit as the recording deck, press **REC MODE** repeatedly to set the recording mode.

4 Engage the Play mode of the source player.

5 Engage the Record mode of the recording deck.

6 Stop recording on the recording deck, then stop playback on the source player.

NOTES:

- All necessary cables can be obtained from your dealer.
- For Y/C signal input/output, be sure to use a 21-pin SCART cable that is compatible with the Y/C signal.
- When you use this unit as the source player for editing, be sure to set "SUPERIMPOSE" to "OFF" before starting. (pg. 62)
- If you are using another recorder with S-Video and Audio output connectors, connect its S-Video and Audio output connectors to this unit's [S-VIDEO] and [AUDIO] input connectors on the front panel. Then, set the unit's input mode to "F-1" in step 2, and set "F-1 INPUT" to "S-VIDEO". (pg. 59)

Output/Input Set

- Turn on the TV and select an input mode such as EXT1.

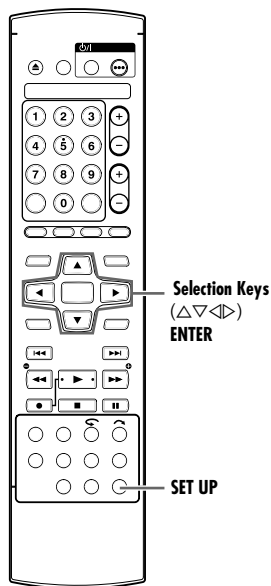

L-1 Output And L-1 Input Setting

The [L-1 IN/OUT] connector accepts and delivers either a composite signal (regular video signal) or a Y/C signal (a signal in which the luminance and chrominance signals are separated). Set "L-1 OUTPUT" and "L-1 INPUT" to the appropriate mode depending on the type of appliance connected to the unit's [L-1 IN/OUT] connector.

- 1 Press **SET UP** to access the Main Menu screen.
- 2 Press **selection keys** to select "FUNCTION SET UP", then press **ENTER**.
- 3 Press **selection keys** to select "VIDEO IN/OUT", then press **ENTER** for confirmation.
- 4 Press **selection keys** to select "L-1 OUTPUT" or "L-1 INPUT", then press **ENTER**.
- 5 Press **selection keys** to select the appropriate setting, then press **ENTER**.
- 6 Press **SET UP** to complete the setting.

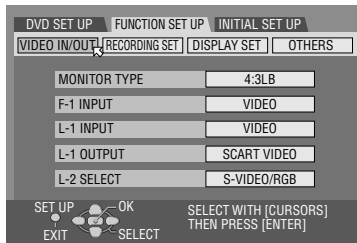

* The **boldface** settings below indicate the settings at your purchase.

■ L-1 OUTPUT — **SCART VIDEO** / SCART S-VIDEO / SCART RGB / COMPONENT

SCART VIDEO:

If a connected appliance's input is compatible only with regular video signals, set to "SCART VIDEO".

SCART S-VIDEO:

If a connected appliance's input is compatible with Y/C signals, set to "SCART S-VIDEO". You can obtain a high-quality picture. (For connection, be sure to use a 21-pin SCART cable that is compatible with the Y/C signal.)

SCART RGB:

If a connected appliance's input is compatible with RGB signals, set to "SCART RGB". You can obtain a high-quality RGB picture.

COMPONENT:

If a connected appliance's input is compatible with Y/P_B/P_R signals, set to "COMPONENT". You can obtain a high-quality Y/P_B/P_R picture. Switch the TV to the input that you can watch component video pictures.

■ L-1 INPUT — **VIDEO** / S-VIDEO

VIDEO:

If a connected appliance's output is compatible only with regular video signals, set to "VIDEO".

S-VIDEO:

If a connected appliance's output is compatible with Y/C signals, set to "S-VIDEO". You can obtain a high-quality picture. (For connection, be sure to use a 21-pin SCART cable that is compatible with the Y/C signal.)

NOTES:

- If "L-1 OUTPUT" is set to "SCART S-VIDEO" or "SCART RGB", it is not possible to set "L-1 INPUT" to "S-VIDEO".
- If "L-2 SELECT" is set to "SAT S-VIDEO/RGB" or "DECODER", it is not possible to set "L-1 INPUT" to "S-VIDEO".
- If "L-2 SELECT" is set to "DECODER", it is only possible to set "L-1 OUTPUT" to "SCART VIDEO".
- Component video signals are not output from the [L-1 IN/OUT] connector.
- When Progressive scan mode is engaged, it is not possible to select the setting of "L-1 OUTPUT". (pg. 58)

L-2 Select Setting

Set "L-2 SELECT" to the appropriate mode depending on the type of appliance connected to the unit's [L-2 IN/DECODER] connector.

- 1 Perform steps 1 and 2 of "L-1 Output And L-1 Input Setting" (pg. 58).
- 2 Press **selection keys** to select "L-2 SELECT", then press **ENTER** for confirmation.
- 3 Press **selection keys** to select the appropriate setting, then press **ENTER**.
- 4 Press **SET UP** to complete the setting.

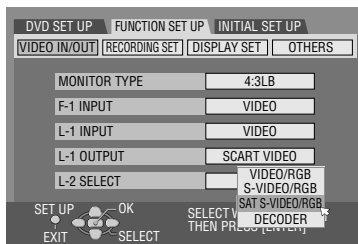

* The **boldface** settings below indicate the settings at your purchase.

■ L-2 SELECT — VIDEO/RGB / S-VIDEO/RGB / SAT VIDEO/RGB / SAT S-VIDEO/RGB / DECODER

Select "VIDEO/RGB" or "S-VIDEO/RGB" to use this unit as the recording deck with the player connected to the [L-2 IN/DECODER] connector, or to use the satellite receiver connected to the [L-2 IN/DECODER] connector.

VIDEO/RGB:

If a connected appliance's output is compatible with regular video signals, set to "VIDEO/RGB".

S-VIDEO/RGB:

If a connected appliance's output is compatible with Y/C signals, set to "S-VIDEO/RGB". You can obtain a high-quality picture. (For connection, be sure to use a 21-pin SCART cable that is compatible with the Y/C signal.)

Select "SAT VIDEO/RGB" or "SAT S-VIDEO/RGB" to view a satellite programme with the TV set while the unit is turned off.

SAT VIDEO/RGB:

If a connected satellite receiver's output is compatible with regular video signals, set to "SAT VIDEO/RGB".

SAT S-VIDEO/RGB:

If a connected satellite receiver's output is compatible with Y/C signals, set to "SAT S-VIDEO/RGB". You can obtain a high-quality S-VHS picture. (For connection, be sure to use a 21-pin SCART cable that is compatible with the Y/C signal.)

DECODER*:

To use a decoder connected to the [L-2 IN/DECODER] connector.

* This setting is not available in the U.K.

NOTES:

- When RGB signals are output from the connected appliance such as a satellite receiver, the unit will record in RGB signals except when "L-2 SELECT" is set to "DECODER".
- If you have a satellite receiver connected to the [L-2 IN/DECODER] connector, be sure to set "L-2 SELECT" back to appropriate mode after editing.
- When you want to play back and record RGB picture, connect the satellite receiver's RGB compatible output connector to the unit's input connector.
- If you are not connecting a satellite receiver to the [L-2 IN/DECODER] connector, leave "L-2 SELECT" set to "VIDEO/RGB".
- When "L-2 SELECT" is set to "SAT VIDEO/RGB" and "SAT S-VIDEO/RGB", "SAT" appears on the TV screen or front display panel instead of "L-2".
- If "L-1 OUTPUT" is set to "SCART S-VIDEO", it is not possible to set "L-2 SELECT" to "DECODER" or "SAT VIDEO/RGB".
- If "L-1 OUTPUT" is set to "SCART RGB", it is not possible to set "L-2 SELECT" to "DECODER" or "SAT S-VIDEO/RGB".
- If "L-1 OUTPUT" is set to "COMPONENT" and "L-2 SELECT" to "SAT VIDEO/RGB", "SAT S-VIDEO/RGB" or "DECODER", be sure to connect the [L-1 IN/OUT] connector with a TV.

- If "L-2 SELECT" is set to "SAT S-VIDEO/RGB", be sure to set "L-1 OUTPUT" to "SCART S-VIDEO".

F-1 Input Setting

Set "F-1 INPUT" to the appropriate mode depending on the connector ([VIDEO] or [S-VIDEO]) being used on the front panel.

- 1 Perform steps 1 and 2 of "L-1 Output And L-1 Input Setting" (pg. 58).
- 2 Press **selection keys** to select "F-1 INPUT", then press **ENTER** for confirmation.
- 3 Press **selection keys** to select the appropriate setting, then press **ENTER**.
- 4 Press **SET UP** to complete the setting.

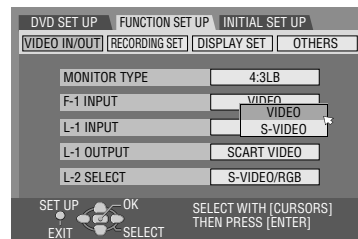

* The **boldface** settings below indicate the settings at your purchase.

■ F-1 INPUT — VIDEO / S-VIDEO

VIDEO:

When connecting an appliance to the [VIDEO] input connector, set to "VIDEO".

S-VIDEO:

- When connecting an appliance to the [S-VIDEO] input connector, set to "S-VIDEO".

Connecting To A Satellite Receiver

Connect the satellite receiver to the [L-2 IN/DECODER] connector, then connect the [L-1 IN/OUT] connector to the TV's connector.

NOTES:

- Set "L-2 SELECT" to "VIDEO/RGB" or "S-VIDEO/RGB". (pg. 59)
- You can use the Automatic Satellite Programme Recording function with this connection. (pg. 43)
- To record a programme via the satellite receiver, select L-2 mode by pressing **PR +/-** so that "L-2" appears on the front display panel.
- For details, refer to the instruction manual of the satellite receiver.

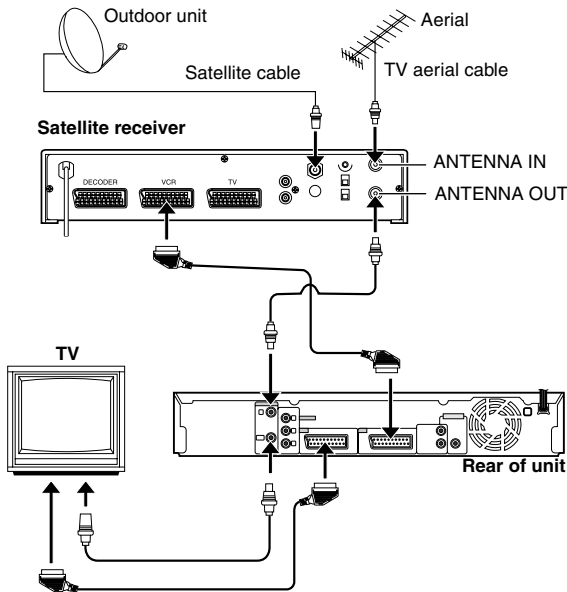

IMPORTANT

When you set "L-2 SELECT" to "SAT VIDEO/RGB" or "SAT S-VIDEO/RGB" (pg. 59), it is possible to view a satellite broadcast with the TV set to an input mode such as EXT1 even if the unit is turned off. When the unit is in Stop mode or recording, press **TV** on the remote control to turn off the Video indicator on the front display panel.

- If you turn on the unit when the satellite receiver's power is off, nothing appears on the TV screen. In this case, turn on the satellite receiver, or set the TV to its TV mode, or press **TV** on the remote control to set the unit to the AV mode.

Connecting To A Dolby Digital Decoder Or An Amplifier With Built-in DTS

These instructions enable you to connect your unit to a Dolby Digital Decoder or an amplifier with built-in DTS.

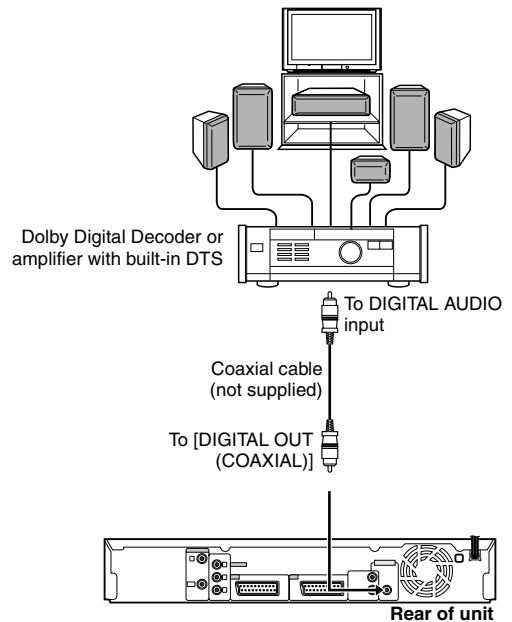

- 1 Connect the unit and a Dolby Digital Decoder or an amplifier with built-in DTS using an optional coaxial cable.

NOTE:

For details on [DIGITAL AUDIO OUT] connector setting, refer to "DIGITAL AUDIO OUT". (pg. 61)

When you can't switch the audio channel of a bilingual programme

When the unit is connected with a digital audio device using an optional coaxial cable and "DIGITAL AUDIO OUT" is set to "DOLBY DIGITAL/PCM", it is not possible to switch the audio channel of a bilingual programme recorded on a DVD-RAM or DVD-RW (VR mode) disc. (pg. 61). In this case, perform the following steps using the remote control to switch "DIGITAL AUDIO OUT" from "DOLBY DIGITAL/PCM" to "PCM ONLY".

- 1 Press **SET UP** to access the Main Menu screen.
- 2 Press **selection keys** to select "DVD SET UP", then press **ENTER**.
- 3 Press **selection keys** to select "AUDIO OUTPUT", then press **ENTER**.
- 4 Press **selection keys** to select "DIGITAL AUDIO OUT", then press **ENTER**.
- 5 Press **selection keys** to select "PCM ONLY", then press **ENTER**.
- 6 Press **SET UP** to complete the setting.
- 7 Press **AUDIO** during playback to select the desired audio channel.

Mode Set

- Turn on the unit.
- Turn on the TV and select an input mode such as EXT1.

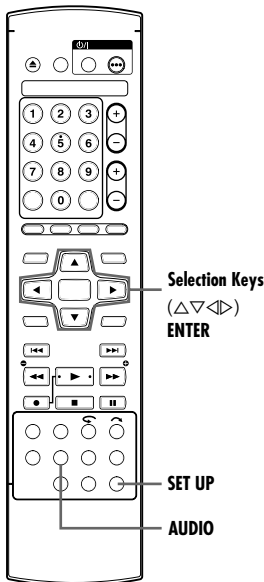

Various modes of this unit are categorised into menus nested in 2 levels shown in the following table. To change the settings of these modes, find the desired mode in the menu, then follow the procedure below. (For details on each menu, see pages 61 – 62)

DVD SET UP	LANGUAGE SET (pg. 21) AUDIO OUTPUT (pg. 61) UTILITY (pg. 70, 71)
FUNCTION SET UP	VIDEO IN/OUT (pg. 22, 58) RECORDING SET (pg. 62) DISPLAY SET (pg. 62) OTHERS (pg. 63)
INITIAL SET UP	AUTO CH SET (pg. 19, 66) MANUAL CH SET (pg. 67) GUIDE PR (pg. 65) CLOCK SET (pg. 69)

- The procedure below shows how to set the desired option of the "AUDIO REC" mode as an example.

1 Press **SET UP** to access the Main Menu screen.

2 Press **selection keys** to select "FUNCTION SET UP", then press **ENTER**.

3 Press **selection keys** to select "RECORDING SET", then press **ENTER**.

4 Press **selection keys** to select "AUDIO REC", then press **ENTER**.

5 Press **selection keys** to select the desired setting, then press **ENTER**.

6 Press **SET UP** to complete the setting.

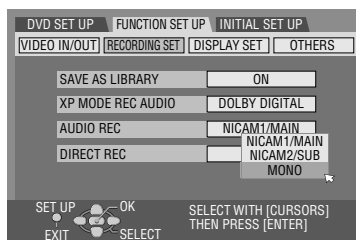

* The **boldface** settings below indicate the settings at your purchase.

AUDIO OUTPUT

DIGITAL AUDIO OUT — DOLBY DIGITAL/PCM / STREAM/ PCM / PCM ONLY

Set to the appropriate mode according to the type of the device connected to [DIGITAL AUDIO OUT] connector.

DOLBY DIGITAL/PCM:

Select this when you connect the digital input connector of a Dolby Digital Decoder or an amplifier with a built-in Dolby Digital Decoder.

STREAM/PCM:

Select this when you connect the digital input connector of an amplifier with a built-in DTS, Dolby Digital, or MPEG multichannel decoder.

PCM ONLY:

Select this when you connect the linear PCM digital input of other audio equipment (amplifier, MD or DAT deck, etc.).

NOTE:

If you watch or play back a programme recorded on a DVD-RAM or DVD-RW (VR mode only) disc which contains multiple audio languages, select "PCM ONLY" in advance and choose main or sub audio with **AUDIO**.

ANALOG AUDIO OUT — STEREO / DOLBY SURROUND

Select the appropriate setting to accommodate the unit to the connected A/V equipment. This function takes effect when a DVD VIDEO disc is played back.

STEREO:

Select this when listening to conventional two-channel stereo audio with the unit's [AUDIO OUT] connectors connected to a stereo amplifier/receiver or TV set, or in case you want to record the audio from a DVD VIDEO disc to a Mini Disc, etc.

DOLBY SURROUND:

Select this when listening to audio with the unit's [AUDIO OUT] connectors connected to an amplifier/receiver with a built-in surround decoder or a surround decoder.

D. RANGE CONTROL — NORMAL / WIDE RANGE / TV MODE

The dynamic range (the difference between the loudest sound and the quietest one) can be compressed during playback of a programme encoded in Dolby Digital format. This function takes effect when a DVD VIDEO disc recorded in Dolby Digital format is played back at low or middle volume.

NORMAL:

Normally select this setting to activate this function.

WIDE RANGE:

Select this to deactivate this function when you enjoy wide dynamic range programme.

TV MODE:

Select this when connecting to a TV. Even soft sound can be well heard.

NOTES:

- This function has no effect on programmes other than those recorded in Dolby Digital format.
- The effect of "NORMAL" and "WIDE RANGE" may not be different depending on discs.

OUTPUT LEVEL — STANDARD / LOW

You can lower the output level of analogue audio to accommodate the unit to the connected A/V equipment.

STANDARD:

Normally select this setting.

LOW:

The output level of analogue audio is lowered.

RECORDING SET**■ SAVE AS LIBRARY — OFF / ON**

When this function is set to “ON”, the recording information is automatically stored in the library. For details, refer to “Edit Library Information” (pg. 52).

■ XP MODE REC AUDIO — DOLBY DIGITAL / LINEAR PCM

You can select the audio format when you record a title in XP mode. When this function is set to “LINEAR PCM”, you can obtain a high-quality audio sound.

DOLBY DIGITAL:

To record in Dolby Digital format.

LINEAR PCM:

To record in Linear PCM format.

■ AUDIO REC — NICAM1/MAIN / NICAM2/SUB / MONO

You can select the desired NICAM audio channel to be recorded on a DVD-R/RW (Video mode) disc.

NICAM1/MAIN:

To record the main language of NICAM audio.

NICAM2/SUB:

To record the sub language of NICAM audio.

MONO:

To record the standard (monaural) sound of NICAM audio.

NOTE:

This function works only for the NICAM bilingual programme.

■ DIRECT REC — OFF / ON

When this function is set to “ON”, you can easily start recording the programme that you are watching on your TV. While holding ●, press ► on the remote control, or press ● on the unit.

NOTES:

- When you use the Direct Rec function, be sure to use a TV offering T-V LINK, etc. and connect a fully-wired 21-pin SCART cable between the unit and the TV. (pg. 17)
- If “DIRECT REC” is set to “OFF”, the ● button functions as described in “Basic Recording” (pg. 35).
- During Direct Rec, “--” appears on the front display panel.
- If a programme is recorded with the Direct Rec, the station name will not be registered in the library. “----” will be displayed for the station name.
- Even if there is no power supply for more than 60 minutes, the unit keeps the setting.

DISPLAY SET**■ SUPERIMPOSE — OFF / AUTO**

When this function is set to “AUTO”, various operational indicators appear on the TV screen.

OFF:

To turn off superimposed indications.

AUTO:

To superimpose operational indications for approximately five seconds just after the corresponding operation.

NOTES:

- Even when “SUPERIMPOSE” is set to “OFF”, you can display the various operational indicators by pressing **ON SCREEN** on the remote control. To clear the operational indicators, press **ON SCREEN** again.
- When you use this unit as the source player for editing, be sure to set “SUPERIMPOSE” to “OFF” before starting. (pg. 57)
- When you select “AUTO”, during playback, the operation mode indicators may be disturbed depending on the type of disc being used.

■ GREY BACK — OFF / ON**OFF:**

Select this when you want to receive an unstable channel with poor signals.

ON:

When this function is set to “ON”, the TV screen becomes all grey when receiving a channel not in use.

■ DIMMER — BRIGHT / DIMMED1 / DIMMED2 / OFF

You can change the brightness of the front display panel.

BRIGHT:

Normally select this. To turn on the display and blue lamp of the front display panel.

DIMMED1/DIMMED2:

To change the brightness level, and turn off the blue lamp of the front display panel.

OFF:

To turn off the display and blue lamp of the front display panel.

■ POWER SAVE — OFF / ON

When this function is set to “ON”, you can reduce the power consumption while the unit is turned off.

NOTES:

- During Power Save mode —
— the front display panel will be turned off.
- It takes some time for the unit to complete initialisation after you turn on the unit power, with “HELLO” blinking on the front display panel.

OTHERS

■ AUTO TIMER — OFF / ON

This is the setting for engaging timer recording standby mode.

OFF:

Press **TIMER** to engage timer recording standby mode.

ON:

Timer recording standby mode is automatically engaged when the unit is turned off.

■ RESUME — OFF / ON / DISC RESUME

When this function is set to "ON" or "DISC RESUME", you can use the resume function.

OFF:

You cannot use the resume function.

ON:

The resume function works on the disc loaded on the unit.

DISC RESUME:

The unit retains a memory of the resume points of the last 30 discs played back, even though they have been ejected.

NOTE:

"DISC RESUME" setting works on DVD VIDEO, VCD, SVCD and finalised DVD-R/DVD-RW (Video mode) discs. For other types of discs, the function under "ON" setting will be applied even if "RESUME" is set to "DISC RESUME".

Remote Control Functions

Remote Control 1/2/3/4 Code Switching

The remote control is capable of controlling four JVC video units independently. Each of the units can respond to one of the four codes (1, 2, 3 or 4). The remote control is preset to send code 3 signals because your unit is initially set to respond to code 3 signals. You can easily modify your unit to respond to code 1, 2 or 4 signals.

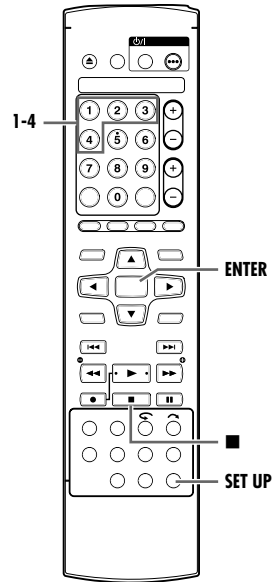
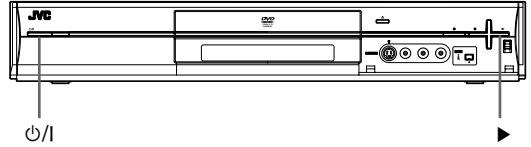

- Keep pressing **SET UP** down during step 1.

- 1** Press the **number key "1"** for 1, **"2"** for 2, **"3"** for 3 or **"4"** for 4 to change the remote control code, then press **ENTER**.
- 2** Press **power/standby** on the unit to turn off the unit.
- 3** Press **right arrow** on the unit for over 5 seconds while the unit is turned off. The code currently set appears on the front display panel.
- 4** Press **square** on the remote control to change the unit's code. The code currently set on the remote control blinks on the front display panel for approximately 5 seconds, and is applied to the unit.

Scan Mode Set

If you connect the unit and TV with Component Video Connection (pg. 11), you can select the scan mode from two modes: Interlaced scan mode which is used in the conventional TV system, and Progressive scan mode which enables reproduction of higher-quality images.

Interlaced scan

In the conventional video system, a picture is shown on the display monitor in two halves. The Interlaced scan system places lines of the second half of the picture in-between lines of the first half of the picture.

Progressive scan

Progressive scan displays all the horizontal lines of a picture at one time, as a single frame. This system can convert the interlaced video from DVD into progressive format for connection to a progressive display. It dramatically increases the vertical resolution.

ATTENTION:

- Your TV needs to be compatible with Progressive.
- Connect the unit and the TV using a component video cable.

- Turn on the unit.
- Turn on the TV and select an input mode such as EXT1.

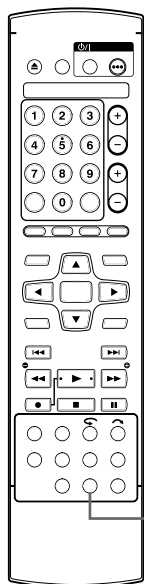

PROGRESSIVE SCAN

- 1 Set "L-1 OUTPUT" to "COMPONENT". (pg. 58)
- 2 Press **PROGRESSIVE SCAN** for 3 or more seconds.
 - Video output indicator (P) lights on the front display panel if Progressive scan mode has been established. (pg. 13)
 - Each press of **PROGRESSIVE SCAN** for 3 or more seconds switches the scan mode.

NOTES:

- Progressive scan video signal is output from the [COMPONENT VIDEO OUT] connectors.
- Interlaced scan mode is the setting at your purchase.
- Interlaced scan mode might be suitable depending on video material.
- Scan mode cannot be set while menu screen is displayed.

Tray Lock

You can lock the disc tray to prohibit the unwanted disc ejection by children.

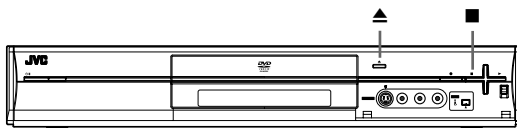

To lock tray

When the unit is turned off, while holding ■, press ▲ on the unit. "LOCK" appears on the front display panel and the disc tray is locked.

To unlock tray

When the unit is turned off, while holding ■, press ▲ on the unit. "UNLOCK" lights up on the front display panel.

Child Lock

You can disable the operations of this unit using the Child Lock function.

- Turn on the unit.

- 1 When the unit is turned on, press and hold **DVD** (P) on the remote control for more than 10 seconds.
 - The unit turns off and enters into Child Lock mode.
 - When in Child Lock mode, "CL" will appear on the front display panel indicating that Child Lock mode is engaged when an attempt was made to operate buttons on the unit or remote control.
- 2 Press and hold **DVD** (P) on the remote control for 10 or more seconds.
 - Child Lock is released and the unit turns on.

When in Child Lock mode, pressing **TIMER** (T) on the remote control during timer recording releases Child Lock and recording is continued.

VIDEO Plus+ System Setup

IMPORTANT:

Normally, Auto Set Up (pg. 18), Preset Download (pg. 19) or Auto Channel Set (pg. 66) sets the Guide Programme numbers automatically. You need to set the Guide Programme numbers manually only in the following cases.

- When timer programming with the VIDEO Plus+ system, the channel position, where the station you wish to record is received on your unit, is not selected,
- OR**
- when you add a channel after Auto Set Up, Preset Download or Auto Channel Set has taken place,
- Set the Guide Programme number for that station manually.

- Turn on the unit.
- Turn on the TV and select an input mode such as EXT1.

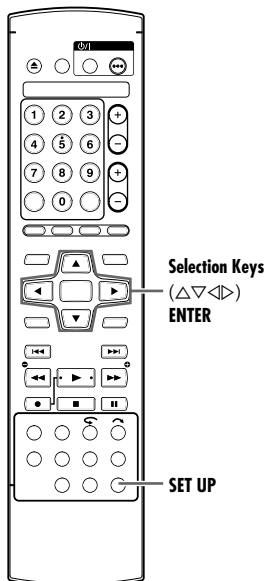

Guide Programme Number Set

- 1 Press **SET UP** to access the Main Menu screen.
- 2 Press **selection keys** to select "INITIAL SET UP", then press **ENTER** for confirmation.
- 3 Press **selection keys** to select "GUIDE PR", then press **ENTER** for confirmation.

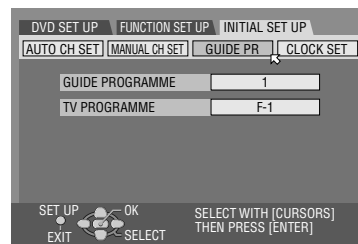

- 4 Press **selection keys** to select "GUIDE PROGRAMME", then press **ENTER** for confirmation.

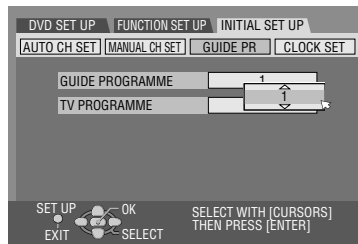

- 5 Press **selection keys** to select the Guide Programme number for the desired station as shown in the TV listings. Then press **ENTER**.

- To change the Guide Programme number in 10 programme increments, press and hold Δ ∇ .

- 6 Press **selection keys** to select "TV PROGRAMME", then press **ENTER**. Press **selection keys** to select the number of the unit's channel position on which the Guide Programme number's broadcast is received by the unit. Then press **ENTER**.

- Repeat steps 5 – 6 as necessary.

- 7 Press **SET UP** to complete the setting.

Guide Programme Number

"Guide Programme (GUIDE PROGRAMME) number" refers to the assigned TV station numbers, according to broadcast area, for the VIDEO Plus+ timer recording. The Guide Programme Numbers can be found in most TV listings.

Tuner Set

Your unit needs to memorise all necessary stations in channel positions in order to record TV programmes. Auto Channel Set automatically assigns all receivable stations in your area to call them up by using the **PR +/-** buttons without going through any vacant channels.

- Turn on the unit.
- Turn on the TV and select an input mode such as EXT1.

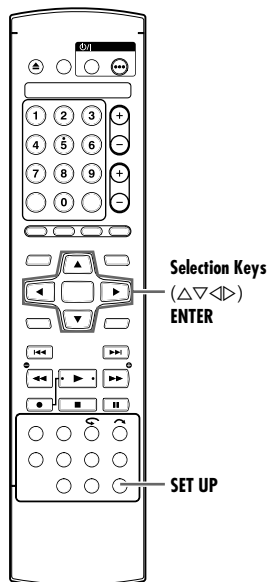

IMPORTANT:

Perform the following steps only if —
 — Auto Channel Set has not been set correctly by Auto Set Up or by Preset Download. (pg. 18, 19)
 — you have moved to a different area or if a new station starts broadcasting in your area.

Auto Channel Set

- 1 Press **SET UP** to access the Main Menu screen.
- 2 Press **selection keys** to select "INITIAL SET UP", then press **ENTER** for confirmation.
- 3 Press **selection keys** to select "AUTO CH SET", then press **ENTER** for confirmation
 - When you have connected the unit to a TV offering T-V Link via a fully-wired 21-pin SCART cable (pg. 17), the unit automatically performs the Preset Download and the T-V LINK screen will appear. (pg. 20)
 - The Auto Set screen appears, and remains on screen while the unit searches for receivable stations.
- 4 After completing Auto Channel Set, press **ENTER**. When Auto Channel Set is completed, "SCAN COMPLETED" appears on screen
- 5 Press **SET UP** to complete the setting.
 - Using the Confirmation screen, you can skip or add channel positions, enter station names and perform other operations. Refer to pages 67 – 68 for the procedures.
 - Depending on reception conditions, the stations may not be stored in order, and the station names may not be stored correctly.

IMPORTANT:

- In certain reception conditions, station names may not be stored correctly, and Auto Guide Programme Number Set may not work properly. When the Guide Programme numbers are not set properly, the programme that you do not intend to record will be timer recorded by the VIDEO Plus+ system of the unit. When programming the timer using the VIDEO Plus+ system, be sure to check the desired channel is selected correctly. "Check, Cancel And Change Programmes" (pg. 42)
- Your unit memorises all receivable stations even if reception of some of them is poor. You can delete those stations with an unacceptable picture from the list. (pg. 67, "Delete A Channel")

NOTES:

- Fine tuning is performed automatically during Auto Channel Set. If you want to perform tuning manually, refer to "Fine-Tuning Channels Already Stored" (pg. 68).
- If you perform Auto Channel Set when the aerial cable is not connected properly, "SCAN COMPLETED-NO SIGNAL-" appears on the TV screen in step 4. In such a case, make sure of the aerial connection and press **ENTER**; Auto Channel Set will start again.

Manual Channel Set

Store channels that were not stored during Auto Set Up (pg. 18), Preset Download (pg. 19) or Auto Channel Set (pg. 66).

- 1 Press **SET UP** to access the Main Menu screen.
- 2 Press **selection keys** to select "INITIAL SET UP", then press **ENTER** for confirmation.
- 3 Press **selection keys** to select "MANUAL CH SET", then press **ENTER**.
- 4 Press **selection keys** to select a blank position in which you want to store a channel, then press **ENTER** twice.
- 5 Press **selection keys** to select "BAND", then press **ENTER**.

(Example) To store in position 6.

DVD SET UP			FUNCTION SET UP			INITIAL SET UP		
INITIAL SET UP / MANUAL CH SET								
PR	CH	ID	PR	CH	ID			
01	26	BBC1	08		----			
02	33	BBC2	09		----			
03	23	ITV	10		----			
04	30	CH4	11		----			
05	37	CH5	12		----			
06			13		----			
07			14		----			

SET UP OK RETURN SELECT SELECT WITH [CURSORS] THEN PRESS [ENTER]

DVD SET UP			FUNCTION SET UP			INITIAL SET UP		
INITIAL SET UP / MANUAL CH SET								
BAND			CH		CC			
CH			ID		E-SP			
DECODER		OFF						
FINE		◀- ■■■■ ■■■■▶						

SET UP OK RETURN SELECT SELECT WITH [CURSORS] THEN PRESS [ENTER]

- 6 Press **selection keys** to change the band between CH (regular) and CC (cable), then press **ENTER**.
- 7 Press **selection keys** to select "CH", then press **ENTER** for confirmation.
- 8 Press **selection keys** to select a channel number you want to store, then press **ENTER**.
 - To enter the registered station name (pg. 76), press **selection keys** to select "ID", then press **ENTER**. Press Δ ∇ .
 - For fine tuning adjustment, press **selection keys** to select "FINE". Press \langle \rangle to perform fine-tuning.
 - When "L-2 SELECT" is set to "VIDEO/RGB", "S-VIDEO/RGB", "SAT VIDEO/RGB" or "SAT S-VIDEO/RGB", the "DECODER" setting cannot be changed. (pg. 59)
- 9 Press **SET UP** or **RETURN** 3 times to complete the setting.
 - To change positions, see "Change Station Channel Position" (pg. 67).
 - If you wish to set station names other than the ones registered in your unit, see "Set Stations (B)" (pg. 68).

ATTENTION:

Guide Programme numbers are not set when channels are stored manually. (pg. 65, "VIDEO Plus+ System Setup")

Delete A Channel

- 1 Perform steps 1 – 3 of "Manual Channel Set" (pg. 67).
- 2 Press **selection keys** to select the channel you want to delete.
- 3 Press **CANCEL** to delete a channel. The channel next to the cancelled one moves up one line.
 - Repeat steps 2 – 3 as necessary.
- 4 Press **SET UP** or **RETURN** twice to complete the setting.

Change Station Channel Position

- 1 Perform steps 1 – 3 of "Manual Channel Set" (pg. 67).
- 2 Press **selection keys** to select the channel you want to move, then press **ENTER**.
- 3 Press **selection keys** to select the new channel position, then press **ENTER**.

Example: If you moved the station in position 4 to position 2, the stations originally in positions 2 and 3 each move down one space.

PR	CH	ID	PR	CH	ID
01	26	BBC1	08		----
02	23	ITV	09		----
03	30	CH4	10		----
04	33	BBC2	11		----
05	37	CH5	12		----
06			13		----
07			14		----

PR	CH	ID	PR	CH	ID
01	26	BBC1	08		----
02	23	ITV	09		----
03	30	CH4	10		----
04	33	BBC2	11		----
05	37	CH5	12		----
06			13		----
07			14		----

- Repeat steps 2 – 3 as necessary.
- 4 Press **SET UP** or **RETURN** twice to complete the setting.

Set Stations (A)

Set station names that are registered in your unit.

- 1** Perform steps **1 – 3** of “Manual Channel Set” (pg. 67).
- 2** Press **selection keys** to select the channel you want to modify, then press **ENTER** twice. The setting screen appears.
- 3** Press **selection keys** to select “ID”, then press **ENTER** for confirmation.
- 4** Press **selection keys** to select the desired ID from the registered station names ID (pg. 76), then press **ENTER**.
 - The confirmation screen appears.
- 5** Press **selection keys** to select “OK”, then press **ENTER**.
- 6** Press **SET UP**.
 - Repeat steps **2 – 5** as necessary.
- 7** Press **SET UP** or **RETURN** twice to complete the setting.

Set Stations (B)

Set station names other than the ones registered in your unit.

- 1** Perform steps **1 – 3** of “Manual Channel Set” (pg. 67).
- 2** Press **selection keys** to select the channel you want to modify, then press **ENTER** twice. The setting screen appears.
- 3** Press **selection keys** to select “ID”, then press **ENTER** twice for confirmation.
 - The confirmation screen appears.
- 4** Press **selection keys** to move the arrow to the character entry field.
- 5** Press **selection keys** to select the desired characters (A–Z, 0–9, –, *, +, — (space)), then press **ENTER** at the character entry position.
 - You can enter up to 4 letters.
- 6** Confirm the arrow is on “OK”, then press **ENTER**.
- 7** Press **SET UP** to return to the Manual Channel Set screen.
 - Repeat steps **2 – 7** as necessary.
- 8** Press **SET UP** or **RETURN** twice to complete the setting.

NOTE:

The characters available for the station name (ID) are A–Z, 0–9, –, *, +, — (space) (maximum of 4).

Fine-Tuning Channels Already Stored

- 1** Perform steps **1 – 3** of “Manual Channel Set” (pg. 67).
- 2** Press **selection keys** to select the channel you want to fine-tune, then press **ENTER** twice. The setting screen appears.
- 3** Press **selection keys** to select “FINE”.
- 4** Press <|> until the picture appears in its best quality.
 - Repeat steps **2 – 4** as necessary.
- 5** Press **SET UP** to return to the Manual Channel Set screen.
- 6** Press **SET UP** or **RETURN** twice to complete the setting.

Clock Set

IMPORTANT:

If you performed Auto Set Up (pg. 18) or Preset Download (pg. 19), without ever having set the clock previously, the unit's built-in clock is also set automatically.

Perform the following steps only if —

- Auto Clock Set has not been performed correctly by Auto Set Up or Preset Download.

OR

- you want to change Just Clock setting. (See "Just Clock" in the right column)

- Turn on the unit.
- Turn on the TV and select an input mode such as EXT1.

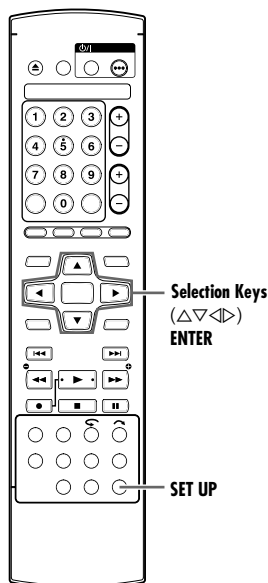

- 1 Press **SET UP** to access the Main Menu screen.
- 2 Press **selection keys** to select "INITIAL SET UP", then press **ENTER** for confirmation.

- 3 Press **selection keys** to select "CLOCK SET", then press **ENTER** for confirmation.

- 4 Press **selection keys** to select "YEAR", then press **ENTER** for confirmation. Press **selection keys** to set the year, then press **ENTER**.

- Repeat the same procedure to set the date and time.
- When you set the date, press and hold $\Delta \nabla$ to change the date by 15 days interval.
- When you set the time, press and hold $\Delta \nabla$ to change the time by 30 minutes interval.

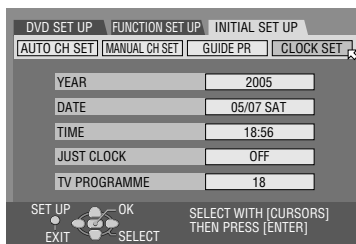

- 5 Press **selection keys** to select "JUST CLOCK", then press **ENTER**. Press **selection keys** to set to the desired mode, then press **ENTER**.
 - The default setting is "OFF".
 - If you set to "OFF", you can disregard the next step as you won't be able to receive regular clock adjustments.
- 6 Press **selection keys** to select "TV PROGRAMME", then press **ENTER**. Press **selection keys** to set the channel position to the number representing the station transmitting clock setting data, then press **ENTER**.
 - The unit is preset to receive clock setting and adjustment data from the channel selected in this step (step 6).
- 7 Press **SET UP** to start the clock operation.

NOTES:

- Just Clock (when set to "ON") adjusts the unit's built-in clock every hour, except for 23:00, 0:00, 1:00 and 2:00.
- Just Clock is not effective when:
 - the unit's power is on.
 - the unit is in the Timer mode.
 - a difference of more than 3 minutes exists between the built-in clock's time and the actual time.
 - the unit is in the Automatic Satellite Programme Recording mode. (pg. 43)
 - "L-2 SELECT" is set to "SAT VIDEO/RGB" or "SAT S-VIDEO/RGB". (pg. 59)
- If Just Clock is set to "ON", the unit's clock is automatically adjusted at the start/end of Summer Time.
- Just Clock may not function properly depending on the reception condition.

Just Clock

The Just Clock function provides accurate time keeping through automatic adjustments at regular intervals, by reading data from a PDC signal.

The Just Clock option can be set to "ON" or "OFF" at the Clock Set screen. (The default setting is "OFF".)

IMPORTANT:

If you turn off Just Clock, the accuracy of your unit's built-in clock may be reduced, which could adversely effect timer recording. We recommend you to keep Just Clock set to "ON". In cases where the clock setting data from a PDC signal is incorrect, however, you are advised to keep Just Clock set to "OFF".

Format A Disc



Some DVD-RAM/RW discs are unformatted. Format the disc when you use an unformatted disc or you want to delete all recordings and data on the disc.

ATTENTION:

- When a disc is formatted, all recordings and data are erased. It is impossible to restore them.
- Never turn off the unit or disconnect the mains power cord while “NOW FORMATTING...” is displayed on the TV screen.

- Turn on the unit.
- Turn on the TV and select an input mode such as EXT1.
- Load a DVD-RAM/RW disc to format.

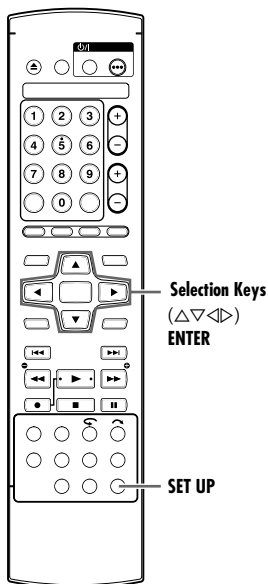

Format A DVD-RAM Disc

- 1 Press **SET UP** to access the Main Menu screen.
- 2 Press **selection keys** to select “DVD SET UP”, then press **ENTER**.
- 3 Press **selection keys** to select “UTILITY”, then press **ENTER**.
- 4 Press **selection keys** to select “FORMAT”, then press **ENTER**.
 - The confirmation screen appears.
- 5 Press **selection keys** to select “YES”, then press **ENTER**.
 - The confirmation screen appears.
- 6 Press **selection keys** to select “OK”, then press **ENTER**.
- 7 Upon completing formatting, “COMPLETED” appears on the TV screen. Press **ENTER** to complete formatting.
- 8 Press **SET UP** to return to the normal screen.

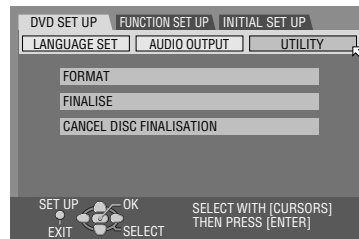

Format A DVD-RW Disc

- 1 Perform steps 1 – 3 of “Format A DVD-RAM Disc” as above before continuing.
- 2 Press **selection keys** to select “FORMAT”, then press **ENTER**. Press **selection keys** to choose “VR MODE” or “VIDEO MODE”, then press **ENTER** when “DISC WILL BE FORMATTED” appears on the TV screen.

“VR MODE”:
To be chosen when you want to record, erase, or edit data on the disc repeatedly.

“VIDEO MODE”:
To be chosen when you want to erase all the data on the disc once played back to record new data, or play back the disc on other DVD players.
- 3 Press **selection keys** to select “YES”, then press **ENTER**.
- 4 Upon completing formatting, “COMPLETED” appears on the TV screen. Press **ENTER** to complete formatting.
- 5 Press **SET UP** to return to the normal screen.

NOTES:

- It is impossible to format Version 1.0 DVD-RW discs in Video mode.
- It is impossible to format DVD-R discs.
- All the titles on a disc will be deleted once the disc is formatted even if they are protected titles.

Finalise A Disc



Finalising DVD-R/RW discs recorded on this unit makes it possible for the discs to be played back on other DVD players. DVD-RW discs are finalised in the mode that the discs were formatted, enabling playback on compatible DVD players.

Title names input in the Library Database Navigation are registered as title names in the DVD menu. (pg. 52)

ATTENTION:

Never turn off the unit or disconnect the AC power cord while finalisation or cancellation of finalisation is in progress.

- Turn on the unit.
- Turn on the TV and select an input mode such as EXT1.
- Load a DVD-R/RW disc to finalise.

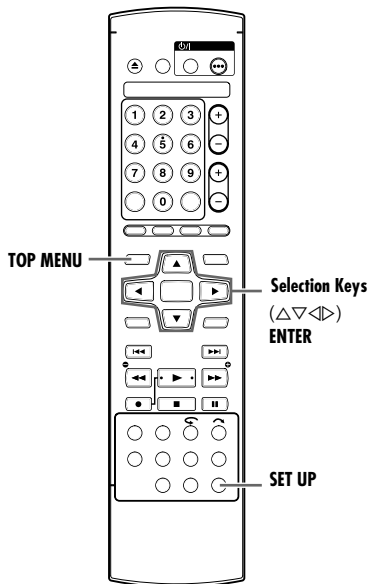

Before finalising

- It is possible to record on a blank space.
- It is possible to enter title names. (pg. 47)
- It is possible to delete titles. (pg. 45)
- It is impossible to overwrite recorded areas of DVD-R discs.
- Available recording capacity does not increase even if a recorded programme is deleted from a DVD-R disc.
- It is impossible to record or edit DVD-R/RW discs recorded on other devices even if they have not been finalised.

After finalising (For DVD-R/RW (Video mode) discs)

- Video and audio that are recorded in conformity to the DVD Video standard before finalising enables you to play back the discs as DVD VIDEO discs.
- Although DVD-R/RW discs finalised on this unit become playable on DVD players compatible with DVD-R/RW discs, some discs still may not play, for which JVC cannot take responsibility.
- Marked points marked before finalising will be deleted, and titles will be divided automatically into "chapters" approximately every 5 minutes. (pg. 8, 26)
- Depending on the DVD players and DVD-R/RW discs used, and on the conditions of recording, it may not be possible to play back the discs. In this case, play back the discs on this unit.
- Additional recordings become impossible.

Finalise A DVD-R/RW Disc

- 1 Perform steps 1 – 3 of "Format A DVD-RAM Disc" (pg. 70) before continuing.
- 2 Press **selection keys** to select "FINALISE", then press **ENTER**.
- 3 The confirmation screen appears. Press **selection keys** to select "YES", then press **ENTER**.
- 4 The confirmation screen appears again. Press **selection keys** to select "OK", then press **ENTER**.
 - To cancel finalisation, press "CANCEL".
- 5 Upon completing finalisation, "COMPLETED" appears on the TV screen. Press **ENTER** to return to the previous screen.
- 6 Press **SET UP** to return to the normal screen.
 - Menu screen is cleared.
 - Once a DVD-R/RW (Video mode) disc has been finalised, the displays for original and play list do not appear. As only display for library appears, press **TOP MENU** to select the desired title.
 - Once a DVD-RW (VR mode) disc has been finalised, it can be played on DVD players compatible with VR mode.

Cancel The Finalisation Of A DVD-RW Disc

- 1 Load a DVD-RW disc to cancel the disc finalisation, and perform steps 1 – 3 of "Format A DVD-RAM Disc" (pg. 70) before continuing.
- 2 Press **selection keys** to select "CANCEL DISC FINALISATION", then press **ENTER**.
- 3 Press **selection keys** to select "OK", then press **ENTER**.
- 4 Upon completing cancellation of finalisation, "COMPLETED" appears on the TV screen. Press **ENTER** to return to the previous screen.
- 5 Press **SET UP** to return to the normal screen.
 - When the disc finalisation is cancelled, the mode in which the disc was formatted is restored, making the disc recordable.
 - It is not possible to cancel the finalisation of a DVD-R disc.

Before requesting service for a problem, use this chart and see if you can solve the trouble yourself. Small problems are often easily solved, and this can save you the trouble of sending your unit off for repair.

Initialising

Malfunction occurs on the unit.

- Press \odot /I to turn off the unit, while holding \odot /I, press ■ for 3 seconds or more.
 - “RESETTING” blinks on the front display panel.
 - Initialisation may be performed automatically depending on the condition of the disc.

General

No power is supplied to the unit.

- The AC power plug is disconnected from the mains outlet.
- Connect the AC power plug to the mains outlet securely. (☞ pg. 17)

The remote control does not work properly.

- Remove the batteries, wait for 5 minutes or more, then load the batteries again.
- The setting of the remote control code is inappropriate.
- Set the same remote control code (1, 2, 3, or 4) on both the unit and the remote control. (☞ pg. 63)
- The batteries are discharged.
- Replace the dead batteries with new ones.

Dubbing from the external equipment is not possible.

- The source (another video recorder, camcorder) has not been properly connected.
- Confirm that the source is properly connected.
- All necessary power switches have not been turned on.
- Confirm that all units' power switches are turned on.
- The setting of the input channel position is inappropriate.
- Select the input channel position (“F-1”, “L-1” or “L-2”) that corresponds to the input terminal connected to the external equipment. (☞ pg. 56)

The on-screen display superimposed on the programme played back/received on this unit is recorded when you dub the programme to an external recording equipment.

- Set “SUPERIMPOSE” to “OFF”. (☞ pg. 62)

The unit does not operate.

- There are cases when the operation is prohibited on the disc.
- Lightning or static electricity may cause malfunction of the unit.
- Disconnect the AC power plug from the AC outlet and connect again. Then turn on the unit.

The remote control of a JVC TV will not operate the unit.

- The setting of the remote control code is inappropriate.
- To operate the unit using a JVC TV remote control, set the remote control code of the unit to “1”. (Default: “3”) (☞ pg. 63)

The channel cannot be changed.

- Recording or Live Memory Playback is in progress.
- Press ■ to pause recording, change the channel, then press ▶ to resume recording.

The disc tray does not open.

- Remove the disc using the following method:
 - Reset the unit by disconnecting the AC power plug from the AC outlet and connect again.
 - Press and hold ▲ until the disc tray opens. (Approximately 30 seconds.)
 - Remove the disc and press ▲ to close the disc tray.
- The disc tray was locked.
- Unlock the tray. (☞ pg. 64)

Playback

Images do not appear on the TV screen.

- The TV receiver's channel selector is not set to an input mode such as EXT1.
- Set the TV to an input mode such as EXT1.
- When interlace scanned programme is played back, progressive scan mode is selected.
- Press and hold **PROGRESSIVE SCAN** until **P** disappears from the front display panel. (☞ pg. 64)

Playback does not start or stop immediately after playback is started by pressing ▶.

On the front display panel, “NO DISC” appears.

- The disc is loaded upside down.
- Place the disc on the disc tray with the playback surface facing down. (☞ pg. 9)
- A disc not being compatible with the unit is loaded.
- Load a playable disc on the unit. (☞ pg. 7)
- A dirty disc is loaded.
- Clean the disc. (☞ pg. 10)
- Defective disc is loaded.
- Replace the warped or scratched disc with a normal one.

Images are blurred or distorted when you start High-Speed Search.

- Images are blurred or distorted at the point where the playback speed changes and this is not a malfunction of the unit.

Playback does not start.

- Playback does not start for approximately 30 seconds after recording is stopped and this is not a malfunction of the unit.

Recording

The desired programme cannot be recorded.

- The channel position does not correspond to that in the receiving area.
- Set the correct channel position for the receiving broadcast. (☞ pg. 19)

Recording and/or editing cannot be performed.

- No disc or a disc not being compatible with the unit is loaded.
- Load a recordable disc on the unit. (☞ pg. 6)
- The disc loaded is not formatted.
- Format the disc. (☞ pg. 70)
- A finalised disc is loaded.
- Recording cannot be made on finalised discs. Load a recordable disc on the unit.
- The disc is full or does not have enough space for the title to be recorded.
- Clear unnecessary titles on the disc or load a blank disc. (☞ pg. 45)

Timer Recording

Timer programming cannot be made.

- Date and time is not correct.
- Set date and time correctly. (☞ pg. 20, 69)
- Timer recording is in progress.
- Timer programming can't be performed while a timer recording is in progress. Wait until it finishes.

Timer programming recording does not start.

- Date and time is not correct.
- Set date and time correctly. (☞ pg. 20, 69)

VIDEO Plus+ Timer Programming cannot be made.

- Date and time is not correct.
- Set date and time correctly. (☞ pg. 20, 69)
- The channel position does not correspond to that in the receiving area.
- Set the correct channel position for the receiving broadcast. (☞ pg. 19, 65)

The VIDEO Plus+ system does not timer record properly.

- The unit's channel positions have been set incorrectly.
- Refer to "Guide Programme Number Set" (☞ pg. 65) and re-perform the procedure.

Automatic Satellite Programme Recording does not start.

- The satellite receiver is not connected properly to this unit.
- Connect the satellite receiver to the unit's [L-2 IN/DECODER] connector properly. (☞ pg. 43)

On the front display panel, " --:-- " appears.

- Power failure occurred.
- Set date and time correctly. (☞ pg. 69)

The disc space does not increase when recorded titles are cleared.

- The PC's data recorded on a DVD-RAM drive cannot be cleared on this unit.
- Format the disc. (When the disc is soiled, wipe the disc with a soft dry cloth before formatting.) (☞ pg. 10, 70)

"PROGRAMME FULL" appears on the TV screen during timer programming.

- All 8 programmes have already been timer programmed.
- Clear unnecessary programmes on the unit, then try timer programming again.

Other Problems

The image of the TV broadcast appears distorted on the TV screen.

- Press **PROGRESSIVE SCAN** for 3 or more seconds so that the Video output indicator (P) lights off on the front display panel.

Whistling or howling is heard from the TV during camcorder recording.

- The camcorder's microphone is too close to the TV.
- Position the camcorder so its microphone is away from the TV.
- The TV's volume is too high.
- Turn the TV's volume down.

When scanning channels, some of them are skipped over.

- Those channels have been designated to be skipped.
- If you need the skipped channels, restore them using "Manual Channel Set". (☞ pg. 67)

Channel settings that were made manually seem to have changed or disappeared.

- After the manual settings were made, Auto Channel Set was performed.
- Do not perform Auto Channel Set after making manual settings, proceed to perform "Clock Set" (☞ pg. 69).

Malfunction occurs and the unit cannot be power off.

- Reset the unit by disconnecting the AC power plug from the AC outlet and connect again.

On-screen Message

DISC NOT REGISTERED IN THE LIBRARY REGISTER DISC?

- A disc that is not registered in the library has been inserted. Register the disc as necessary. (☞ pg. 52)

INSERT DISC #XXXX

- Appears when a title that has been selected in the library is not contained in the loaded disc.

CAN NOT RECORD OR MAKE PLAY LIST DELETE UNWANTED TITLES

- Recording and/or editing cannot be performed.
- The number of titles exceeds 99.
- The number of play lists exceeds 99.

SET CLOCK BEFORE TIMER PROGRAMMING

- To set the timer programme, the clock must be set in advance. (☞ pg. 69)

PROGRAMME FULL DELETE UNWANTED TIMER PROGRAMME

- You can programme this unit to timer record as many as 8 programmes. To programme more, you need to cancel a timer programme already set. (☞ pg. 42)

DISC NOT RECORDABLE INSERT RECORDABLE DISC

- When a playback-only disc or a finalised disc is loaded, ● has been pressed. (☞ pg. 7)

REGION CODE ERROR CHECK DISC

- A disc loaded cannot be played back on this unit since the region number of the disc does not match that of the unit. (☞ pg. 7)

UNREADABLE DISC CHECK DISC

- When an incompatible disc is loaded, ► has been pressed. (☞ pg. 7)

COULD NOT FORMAT THE DISC CHECK THE DISC

- Formatting is not complete since the disc may be dirty or damaged. Take out the disc, clean it and retry. (☞ pg. 10, 70)

PRESS [STOP] AGAIN TO STOP RECORDING

- During Live Memory playback, ■ has been pressed. (☞ pg. 28)

TIMER RECORDING COMPLETED

- Timer recording has finished during Live Memory playback.

PLAYBACK WILL STOP THEN TIMER RECORDING WILL START

- Timer recording finished during Live Memory playback, then the next timer recording is about to begin while playback continues.

COPY PROHIBITED CAN NOT RECORD

- An attempt has been made to record copy-protected contents.
- An attempt has been made to record copy-once contents on a disc that is not CPRM compatible.

COPY PROHIBITED CAN NOT PLAY

- The unit has detected invalid contents at the start or in the middle of playback.

THE I.LINK DEVICE THAT YOU HAVE CONNECTED IS NOT RECOGNIZED MAKE SURE THAT THE DEVICE IS CONNECTED PROPERLY AND POWERED ON

- An attempt has been made to start DV dubbing when a digital video camera is not properly connected to the unit.
- Check the connection. (☞ pg. 54)

MEMORY IS FULL NOTHING MORE CAN BE REGISTERED IN THE LIBRARY IF YOU DELETE UNNECESSARY TITLE INFORMATION, YOU CAN THEN REGISTER ADDITIONAL INFORMATION

- The memory for registration for the Navigation system is full. The recording cannot be started even though the capacity for the recording is enough.

AVAILABLE MEMORY IS LOW SOON YOU WILL NO LONGER BE ABLE TO REGISTER INFORMATION IN THE LIBRARY IF YOU DELETE UNNECESSARY TITLE INFORMATION, YOU CAN THEN REGISTER ADDITIONAL INFORMATION

- The remaining capacity of the memory is not enough for registration for the Navigation system. The recording cannot be started even though the capacity for the recording is enough.

CAN NOT SET DISC TIMER PROGRAMMING WITH THIS DISC PREPARE A FORMATTED DISC AS DESCRIBED BELOW DVD-RAM DVD-RW (VR MODE)

- On-Disc Timer Programming has been attempted when a disc that is not compatible with the function is loaded.

NO DISC INSERTED

- On-Disc Timer Programming has been attempted when a disc is not loaded, or loaded upside down.

PLUSCODE ERROR CONFIRM PLUSCODE THEN RETRY

- An invalid PlusCode number has been input.

GUIDE PROGRAMME IS NOT SET SELECT CHANNEL YOU WANT TO RECORD

- To set the timer programme using the VIDEO Plus+ system, the Guide Programme Number must be set in advance.

CAN NOT SET VIDEO PLUS+ TIMER PROGRAMMING DURING TIMER RECORDING OR INSTANT TIMER RECORDING CANCEL TIMER RECORDING OR INSTANT TIMER RECORDING, THEN ENTER THE SHOWVIEW CODE AGAIN

- Appears when you tried to input a PlusCode number during timer recording or instant timer recording.

COULD NOT FINALISE THE DISC CHECK THE DISC

- Finalising is not complete since the disc may be dirty or damaged. Take out the disc, clean it and retry.

COULD NOT CANCEL DISC FINALISATION CHECK THE DISC

- Cancelling disc finalisation is not complete since the disc may be dirty or damaged. Take out the disc, clean it and retry.

Language Code List

AA	Afar	IN	Indonesian	RU	Russian
AB	Abkhazian	IS	Icelandic	RW	Kinyarwanda
AF	Afrikaans	IW	Hebrew	SA	Sanskrit
AM	Ameharic	JI	Yiddish	SD	Sindhi
AR	Arabic	JW	Javanese	SG	Sangho
AS	Assamese	KA	Georgian	SH	Serbo-Croatian
AY	Aymara	KK	Kazakh	SI	Singhalese
AZ	Azerbaijani	KL	Greenlandic	SK	Slovak
BA	Bashkir	KM	Cambodian	SL	Slovenian
BE	Byelorussian	KN	Kannada	SM	Samoan
BG	Bulgarian	KO	Korean (KOR)	SN	Shona
BH	Bihari	KS	Kashmiri	SO	Somali
BI	Bislama	KU	Kurdish	SQ	Albanian
BN	Bengali, Bangla	KY	Kirghiz	SR	Serbian
BO	Tibetan	LA	Latin	SS	Siswati
BR	Breton	LN	Lingala	ST	Sesotho
CA	Catalan	LO	Laothian	SU	Sundanese
CO	Corsican	LT	Lithuanian	SW	Swahili
CS	Czech	LV	Latvian, Lettish	TA	Tamil
CY	Welsh	MG	Malagasy	TE	Telugu
DZ	Bhutani	MI	Maori	TG	Tajik
EL	Greek	MK	Macedonian	TH	Thai
EO	Esperanto	ML	Malayalam	TI	Tigrinya
ET	Estonian	MN	Mongolian	TK	Turkmen
EU	Basque	MO	Moldavian	TL	Tagalog
FA	Persian	MR	Marathi	TN	Setswana
FJ	Fiji	MS	Malay (MAY)	TO	Tonga
FO	Faroese	MT	Maltese	TR	Turkish
FY	Frisian	MY	Burmese	TS	Tsonga
GA	Irish	NA	Nauru	TT	Tatar
GD	Scots Gaelic	NE	Nepali	TW	Twi
GL	Galician	OC	Occitan	UK	Ukrainian
GN	Guarani	OM	(Afan) Oromo	UR	Urdu
GU	Gujarati	OR	Oriya	UZ	Uzbek
HA	Hausa	PA	Panjabi	VI	Vietnamese
HI	Hindi	PL	Polish	VO	Volapuk
HR	Croatian	PS	Pashto, Pushto	WO	Wolof
HU	Hungarian	PT	Portuguese	XH	Xhosa
HY	Armenian	QU	Quechua	YO	Yoruba
IA	Interlingua	RM	Rhaeto-Romance	ZH	Chinese
IE	Interlingue	RN	Kirundi	ZU	Zulu
IK	Inupiak	RO	Rumanian		

TV Station And ID List

The "ID" abbreviation is what is shown on-screen in lieu of the station name. The "ID" abbreviation is listed in the Confirmation screen and is displayed on the TV screen when the unit is tuned to a different station.

STATION NAME	ID
Anglia TV	ANGL
ARD	ARD
ARTE	ARTE
BBC Group	BBC
BBC1	BBC1
BBC2	BBC2
BBCW	BBCW
Berlin 1	BLN1
Berlin 2	BLN2
Border TV	BORD
Bayern1	BR1
Bayern3	BR3
BRT1	BRT1
BRT2	BRT2
Children Ch	CHLD
Canal +	CH+
CNN	CNN
Channel TV	CHNL
Central TV	CNTR
Channel 4	CH 4
Channel 5	CH 5
DISC	DISC
DRS	DRS
DR TV	DRTV
DSF	DSF
Euronews	EURN
Euronews	EURO
Eurosports	EURS
France1	FR1
France2	FR2
France3	FR3
Granada TV	GRNA
Grampian TV	GRMP
Hessen1	HR1
Hessen3	HR3
HRT	HRT
HTV	HTV
ITV Network	ITV1
Kabelkanal	KABL
London	LNDN
MDR	MDR
MTV	MTV
Nord3	N3
NDR1	NDR1
NDR3	NDR3
NED1	NED1
NED2	NED2
NED3	NED3
Network 2	NET2
NRK	NRK
N-TV	N-TV
Offener Kanal	OKAN
ORF1	ORF1
ORF2	ORF2
ORF3	ORF3
OWL 3	OWL3
Premiere	PRM1
PR07	PR07
RAI1	RAI1
RAI2	RAI2
RAI3	RAI3

STATION NAME	ID
RB1	RB1
RB3	RB3
Rikisutvarpid-S	RKPS
RTBF 1	RTB1
RTBF 2	RTB2
RTE 1	RTE1
RTL	RTL
RTL 2	RTL2
RTP	RTP
SAT	SAT
SAT 1	SAT1
Scottish TV	SCOT
SC4	SC4
SDR	SDR
SDR1	SDR1
SFB1	SFB1
SFB3	SFB3
SKY	SKY
Sky One	SKY1
Sky Net	SKYN
Sport	SPRT
SR 1	SR1
Super RTL	SRTL
STV Test	STVT
STV 1	STV1
STV 2	STV2
Suedwest3	SWR
SWF 1	SWF1
Schweiz4	SWZ4
TYNE TEES	TEES
Text	TEXT
TF1	TF1
TNT int	TNT
TRT int	TRT
TSI	TSI
TSR	TSR
TSW	TSW
TVE	TVE
TV Polonia	TVPA
TVP 1	TVP1
TVP 2	TVP2
TVS	TVS
TV2	TV2
TV5	TV5
Tele Zurich	TZUR
Ulster TV	ULST
Veronica	VERN
VIVA	VIVA
VIVA2	VIV2
VOX	VOX
VTM	VTM
VT4	VT4
West1	WDR1
West3	WDR3
YLE 1	YLE1
YLE 2	YLE2
Yorkshire TV	YORK
ZDF	ZDF
Zurich 1	ZUR1
3SAT	3SAT

TV Station Channel Number Guide

Only the main stations are listed. There are in addition many relay stations, and full lists are available from the BBC and ITV.

	BBC1	BBC2	ITV	CH4	CH5		BBC1	BBC2	ITV	CH4	CH5
London & South-East						North-West					
Bluebell Hill.....	40	46	43	65	—	Caldbeck.....	30	34	28	32	56
Crystal Palace.....	26	33	23	30	37	Winter Hill.....	55	62	59	65	48
Dover.....	50	56	66	53	—	North-East					
Heathfield.....	49	52	64	67	—	Bilsdale West Moor.....	33	26	29	23	35
Oxford.....	57	63	60	53	49	Chatton.....	39	45	49	42	—
South-West						Pontop Pike.....	58	64	61	54	68
Beacon Hill.....	57	63	60	53	—	Scotland					
Caradon Hill.....	22	28	25	32	—	Angus.....	57	63	60	53	—
Huntshaw Cross.....	55	62	59	65	67	Black Hill.....	40	46	43	50	37
Redruth.....	51	44	41	47	37	Sandale.....	22	—	—	—	—
Stockland Hill.....	33	26	23	29	—	Caldbeck.....	—	34	28	32	56
Channel Islands						Creigkelly.....	31	27	24	21	48
Fremont Point.....	51	44	41	47	—	Darvel.....	33	26	23	29	35
South						Durris.....	22	28	25	32	67
Hannington.....	39	45	42	66	35	Eitshal.....	33	26	23	29	—
Midhurst.....	61	55	58	68	—	Keelylang Hill.....	40	46	43	50	—
Rowridge.....	31	24	27	21	—	Knock More.....	33	26	23	29	—
West						Rosemarkie.....	39	45	49	42	67
Mendip.....	58	64	61	54	37	Rumster Forest.....	31	27	24	21	—
East						Selkirk.....	55	62	59	65	52
Sandy Heath.....	31	27	24	21	39	Wales					
Sudbury.....	51	44	41	47	35	Blaenplwyf.....	31	27	24	21	56
Tacolneston.....	62	55	59	65	52	Carmel.....	57	63	60	53	—
Midlands						Llanddona.....	57	63	60	53	—
Ridge Hill.....	22	28	25	32	35	Moel-y-Parc.....	52	45	49	42	—
Sutton Coldfield.....	46	40	43	50	37	Presely.....	46	40	43	50	37
The Wrekin.....	26	33	23	29	35	Wenvoe.....	44	51	41	47	—
Waltham.....	58	64	61	54	35	Northern Ireland					
North						Brougher Mountain.....	22	28	25	32	—
Belmont.....	22	28	25	32	56	Divis.....	31	27	24	21	37
Emley Moor.....	44	51	47	41	37	Limavady.....	55	62	59	65	—

GENERAL**Power requirement**AC 220 V - 240 V \sim , 50 Hz/60 Hz**Power consumption**

Power on: 31 W

Power off: 6.4 W

Temperature

Operating: 5 °C to 35 °C

Storage: -20 °C to 60 °C

Operating position

Horizontal only

Dimensions (WxHxD)

435 mm x 70 mm x 300 mm

Weight

3.4 kg

VIDEO/AUDIO**Recordable disc:** DVD-RAM 12 cm (4.7 GB/9.4 GB)

DVD-RAM 8 cm (1.4 GB/2.8 GB)

DVD-R 12 cm (4.7 GB)

DVD-R 8 cm (1.4 GB)

DVD-RW 12 cm (4.7 GB)

DVD-RW 8 cm (1.4 GB)

Recording format

DVD-RAM : DVD Video Recording format

DVD-R : DVD-Video format

DVD-RW : DVD-Video format, DVD Video Recording format

Recording time

Maximum 8 hours (with 4.7 GB disc)

(XP) : Approx. 1 hour

(SP) : Approx. 2 hours

(LP) : Approx. 4 hours

(EP) : Approx. 6 hours

(FR) : Approx. 1 hour - 8 hours

Audio recording system

: Dolby Digital (2 ch)

Linear PCM (XP mode only)

Video recording compression system

: MPEG2 (CBR/VBR)

Input/Output**S-video input**Y : 1.0 Vp-p, 75 Ω C : 0.3 Vp-p, 75 Ω **Video input** : 1.0 Vp-p, 75 Ω (pin jack)**Audio input** : 2 Vrms (pin jack)**Audio output** : 2 Vrms (pin jack)**21-pin SCART connectors**

: IN/OUT x 1, IN/DECODER x 1

i.Link : 4-pin for DV input**Component video output**Y : 1.0 Vp-p, 75 Ω PB/PR : 0.7 Vp-p, 75 Ω

Corresponding to copy protection

Digital audio output : Coaxial

Corresponding to Dolby Digital and DTS

Digital Surround

Bit stream

Selectable in digital audio output setting

menu

TUNER/TIMER**Tuning system** : Frequency synthesiser tuner**Channel coverage**

VHF : 47 MHz-143 MHz/

143 MHz-470 MHz

UHF : 470 MHz-862 MHz

Clock reference : Quartz**Programme capacity** : 30 days programmable timer/

8 programmes

Memory backup time : Approx. 10 min.**ACCESSORIES****Provided accessories:** RF cable,

21-pin SCART cable,

Infrared remote control unit,

"AA" battery x 2

Specifications shown are for SP mode unless otherwise specified.
E. & O.E. Design and specifications subject to change without notice.

A		O	
A-B Repeat Playback	32	On-Disc Timer Programming	40, 41
Adjusting The Picture Quality	33	One Touch Replay	25
Angle Selection	26	On-screen Bar	31
Audio Channel Selection	27	On-Screen Display	16
Audio Language/Sound Selection	27	P	
Auto Channel Set	66	Pan&Scan	22
Automatic Satellite Programme Recording	43	Play List	48
B		Playback Control (PBC) Function	27
Basic Playback	23	Programme Playback	34
Basic Recording	35	Programmes overlap	42
C		Progressive scan	64
Check, Cancel And Change Programmes	42	R	
Child Lock	64	Random Playback	34
D		Receiving Stereo And Bilingual Programmes	37
Disc menu	24	Recordable/Playable Discs	6
Disc Remaining Time	36	Recording Medium And Format	8
Discs For Playback Only	7	Recording mode	35
DV Dubbing	54	Region Number	7
DVD menu	24	Register Disc	52
E		Repeat Playback	31
Elapsed Recording Time Indication	36	Resume Function	25
F		S	
File Structure Of Discs	8	Select The Switching Interval Of The Slide Show	34
Finalise	71	Selection Of The Audio Channel To Be Recorded On A Disc	37
Format disc	70	Setting The Progressive Mode	33
Frame-By-Frame Playback	24	ShowView Timer Programming	38
Free Rate Function	37	Simultaneous Recording and Playback	29
G		Skip Search	25
Guide Programme Number	65	Slow Motion	25
I		Still Picture	24
Instant Timer Recording (ITR)	36	Subtitle Selection	26
Interlaced scan	64	T	
J		Time Search	33
Just Clock	69	Top menu	24
L		Tray Lock	64
Language Code List	75	TV Station And ID List	76
Letter Box	22	U	
Library Database Navigation	44	Unplayable Discs	7
Live Memory Playback	28	V	
M		VPS/PDC Recording	39
Manual Channel Set	67		
Manual Timer Programming	39		
Marking Positions To Play Back Again Later	26		
Menu/Audio/Subtitle Language Set	21		
Monitor Set	22		



EN

DR-M100S

JVC